



Application manual - Positioning

ACTIVE Cube



General Information about the Documentation

This application manual complements the configurations described in the operating instructions and the „Quick Start Guide“ of the ACU frequency inverters (ACTIVE Cube series). Configurations 240, 440 and 540, which are described in this application manual, contain additional positioning functions.

For better clarity, the documentation is structured according to the customer-specific requirements made on the frequency inverter.

Quick Start Guide

The Quick Start Guide describes the basic steps required for mechanical and electrical installation of the frequency inverter. The guided commissioning supports you in the selection of necessary parameters and the software configuration of the frequency inverter.

Operating Instructions

The Operating Instructions describe and document all functions of the frequency inverter. The parameters required for adapting the frequency inverter to specific applications as well as the wide range of additional functions are described in detail.

Application Manual

The application manual supplements the documentation for purposeful installation and commissioning of the frequency inverter. Information on various subjects connected with the use of the frequency inverter are described specific to the application.

Installation Instructions

Complementing the Brief Instructions and the Operating Instructions, the Installation Instructions provide information on how to install and use the additional/optional components.

If you need a copy of the documentation or additional information, contact your local representative of BONFIGLIOLI.

The following pictograms and signal words are used in the documentation:



Danger!

Danger refers to an immediate threat. Non-compliance with the precaution described may result in death, serious injury or material damage.



Warning!

Warning refers to a possible threat. Non-compliance with the warning may result in death, serious injury or material damage.



Caution!

Caution refers to an immediate hazard. Non-compliance may result in personal or material damage.

Attention!

Attention and the related text refer to a possible behavior or an undesired condition which can occur during operation.

Note

marks information which facilitates handling for you and supplements the corresponding part of the documentation.

TABLE OF CONTENTS

1	General Safety Instructions and Information on Use	5
1.1	General Information	5
1.2	Purpose of the Frequency Inverters	6
1.3	Transport and Storage	6
1.4	Handling and Installation	6
1.5	Electrical Connection	7
1.6	Information on Use.....	7
1.7	Maintenance and Service.....	7
2	System description.....	8
2.1	Terminal diagram ACTIVE Cube (ACU) series.....	9
3	Commissioning of the Frequency Inverter.....	10
3.1	Switching on Mains Voltage	10
3.2	Commissioning of the motor	11
3.3	Control Inputs and Outputs.....	12
3.3.1	Factory settings of the digital inputs.....	13
3.4	Digital inputs for speed sensor inputs or for other functions	15
3.5	Positioning - commissioning procedure	16
3.5.1	Getting started	18
3.5.1.1	Motor encoder is position encoder at the same time.....	18
3.5.1.2	Two different encoders for motor and positioning	19
3.5.1.3	No motor encoder, external encoder for positioning	20
3.5.1.4	Consider the operation mode settings for speed sensor input.....	20
3.5.2	Reference system	21
3.5.3	Setting up a motion profile	24
3.5.4	Control via software.....	25
3.5.5	Write index and read index for the motion blocks table	26
4	Operation Modes of the Positioning.....	28
4.1	General Issues about Operation Modes	28
4.1.1	Assignment of digital inputs.....	29
4.1.1.1	Instructions on MFI1D (multifunction input).....	30
4.1.2	Operation modes for controlling the positioning operation	31
4.1.3	Input and output signals	33
4.2	Homing	34
4.2.1	Automatic of manual start of homing.....	34
4.2.2	Input and output signals for homing.....	35
4.2.3	Homing mode.....	37
4.2.4	Home offset	38
4.2.5	Speed and acceleration of homing operation	38
4.3	Positioning Mode	39
4.3.1	Motion block management.....	39
4.3.2	VTable.....	40
4.4	Positioning Mode And Motion Block Data.....	41
4.4.1	Motion Mode	41
4.4.1.1	Motion mode "absolute".....	44
4.4.1.2	Motion mode "relative"	44
4.4.1.3	Motion mode "touch probe" (sensor)	45
4.4.1.4	Motion mode "velocity".....	47
4.4.1.5	Combination with electronic gear	48

4.4.2	Motion block data	54
4.4.2.1	Target position.....	54
4.4.2.2	Speed	54
4.4.2.3	Acceleration and Deceleration	55
4.4.2.4	Automatic sequence of motion blocks (next motion block)	55
4.4.2.5	Single motion.....	62
4.4.3	Control of motion.....	63
4.4.3.1	Selection of motion block via digital signals (motion block change-over).....	63
4.4.3.2	Motion block selection via parameter (starting-record number)	65
4.4.4	Input and output signals for motion blocks	66
4.4.5	Starting, stopping and resuming	67
4.4.5.1	Starting and stopping positioning.....	68
4.4.5.2	Resuming interrupted motion blocks	72
4.4.6	Digital signals for indication of status of motion orders.....	73
4.5	JOG Mode.....	76
4.5.1	Fixed speed in JOG mode	79
4.5.2	Acceleration and Deceleration in JOG Mode.....	81
4.6	Teach-In (Saving Actual Position as Target Position).....	81
4.7	Electronic gear	85
4.7.1	Master position source	85
4.7.2	Gear factor.....	87
4.7.3	Resynchronization.....	87
4.7.4	Phasing function	87
4.8	Monitoring Functions.....	90
4.8.1	Travel limits	90
4.8.2	Hardware limit switches	90
4.8.2.1	Hysteresis for hardware limit switch.....	93
4.8.2.2	Fault reaction.....	94
4.8.2.3	Move away from HW limit switches.....	95
4.8.3	Software limit switches.....	95
4.8.3.1	Move away from SW limit switches	98
4.8.4	Target window	99
4.8.5	Contouring error supervision.....	100
4.8.6	Warning mask Application	102
4.9	Speed Override	104
4.10	Position Comparator	105
4.11	Rotary Table Application	107
4.12	Position Controller	110
4.13	Store the actual position value (latching function).....	112
4.14	Wiring Example.....	113
5	List of homing modes	115
5.1	Brief Description Homing	115
5.2	Overview Table of Homing Types	117
5.3	Graphic Overview of Homing Modes	118
5.4	Terminology.....	119
5.5	Description of Homing Modes.....	120
5.5.1	Homing Modes with Ref. Signal.....	121
5.5.2	Homing modes without reference signal	137
5.5.3	Homing modes, only ref. signal and actual position.....	150
6	Output Signals and fault messages.....	151
6.1	Actual positioning values.....	151

6.2	Status word of the positioning	152
6.3	Status word 411	154
6.4	Digital Positioning Output Signals.....	155
6.5	Logic Signal Sources for Positioning	156
6.6	Positioning Error Messages	158
6.7	Positioning Warning Status	162
6.8	Diagnosis and fault clearance.....	162
6.8.1	Touch probe: Drive is decelerated or stops	163
6.8.2	Drive jerks/is very load.....	163
7	Parameter List	164
7.1	Actual Value Menu (VAL)	164
7.2	Parameter Menu (PARA).....	164
7.3	Parameter list, sorted by function.....	168
	Index	170

1 General Safety Instructions and Information on Use



Warning! The specifications and instructions contained in the documentation must be complied with strictly during installation and commissioning. Only qualified staff who has read the documentation and, in particular, the safety instructions carefully is allowed to carry out installation or commissioning work or to operate the frequency inverters. The term „Qualified Staff“ refers to anybody who is familiar with the installation, assembly, commissioning and operation of the frequency inverter and has the proper qualification for the job.

The present documentation was prepared with great care and it was subjected to extensive and repeated reviews. For reasons of clarity, it was not possible to include all details of all types of the product in the documentation. Neither was it possible to consider all conceivable installation, operation or maintenance situations. If you require further information or if you meet with specific problems which are not dealt with in sufficient detail in the documentation, contact your national BONFIGLIOLI agent.

We would also like to point out that the contents of this documentation do not form part of any previous or existing agreement, assurance or legal relationship. Neither are they intended to supplement or replace such agreements, assurances or legal relationships. The manufacturer's obligations are exclusively specified in the relevant purchase contract. This contract also contains all and any warranty regulations which may apply to the relevant scope of supply. These contractual warranty provisions are neither extended nor limited by the specifications contained in this documentation.

The manufacturer reserves the right to correct or amend the specifications, product information and omissions in these operating instructions without notice. The manufacturer shall not be liable for any damage, injuries or costs which may be caused by the aforementioned reasons.

1.1 General Information



Warning! The DC-link circuit of the frequency inverter is charged during operation, i.e. there is always the risk of contact with high voltage. Frequency inverters are used for driving moving parts and they may become hot at the surface during operation.

Any unauthorized removal of the necessary covers, improper use, wrong installation or operation may result in serious injuries or material damage.

In order to avoid such injuries or damage, only qualified staff may carry out the transport, installation, setup or maintenance work required. The standards EN 50178, IEC 60364 (Cenelec HD 384 or DIN VDE 0100), IEC 60664-1 (Cenelec HD 625 or VDE 0110-1), BGV A2 (VBG 4) as well as the applicable national regulations must be complied with. The term „Qualified Staff“ refers to anybody who is familiar with the installation, assembly, commissioning and operation of the frequency inverter as well as the possible hazards and has the proper qualification for the job.

1.2 Purpose of the Frequency Inverters



Warning! The frequency inverters are electrical drive components intended for installation in industrial plants or machines. Commissioning and start of operation is not allowed until it has been verified that the machine meets the requirements of the EC Machinery Directive 98/37/EEC and EN 60204. In accordance with the CE marking requirements, the frequency inverters also comply with the Low Voltage Directive 72/23/EEC as well as EN 50178 / DIN VDE 0160 and EN 61800-2. The user shall be responsible for making sure that the requirements of the EMC Directive 89/336/EEC are met. Frequency inverters are only available at specialized dealers and are exclusively intended for professional use as per EN 61000-3-2.

The frequency inverters are also marked with the UL label according to UL508c, which proves that they also meet the requirements of the CSA Standard C22.2-No. 14-95.

The technical data, connection specifications and information on ambient conditions are indicated on the name plate and in the documentation and must be complied with in any case. Anyone involved in any kind of work at the device must have read the instructions carefully and understood them before starting the work.

Do not connect any capacitive loads.

1.3 Transport and Storage

The frequency inverters must be transported and stored in an appropriate way. During transport and storage the devices must remain in their original packaging. The units may only be stored in dry rooms which are protected against dust and moisture and are exposed to little temperature deviations only. Observe the climatic conditions according to EN 50178 and the marking on the packaging. The frequency inverters must not be stored for more than one year without connecting them to nominal voltage.

1.4 Handling and Installation



Warning! Damaged or destroyed components must not be put into operation because they may be a health hazard.

The frequency inverters are to be used in accordance with the documentation as well as the applicable directives and standards. They must be handled carefully and protected against mechanical stress. Do not bend any components or change the isolating distances. Do not touch electronic components or contacts. The devices are equipped with components which are sensitive to electrostatic energy and can easily be damaged if handled improperly. Any use of damaged or destroyed components shall be considered as a non-compliance with the applicable standards. Do not remove any warning signs from the device.

1.5 Electrical Connection



Warning! Before any assembly or connection work, discharge the frequency inverter. Verify that the frequency inverter is discharged. Do not touch the terminals because the capacitors may still be charged. Comply with the information given in the operating instructions and on the frequency inverter label.

When working at the frequency inverters, comply with the applicable standards BGV A2 (VBG 4), VDE 0100 and other national directives. Comply with the electrical installation instructions given in the documentation as well as the relevant directives. The manufacturer of the industrial machine or plant is responsible for making sure that the limit values specified in the EMC product standard EN 61800-3 for electrical variable-speed drives are complied with. The documentation contains information on EMC-conforming installation. The cables connected to the frequency inverters may not be subjected to high-voltage insulation tests unless appropriate circuitry measures are taken before.

1.6 Information on Use



Warning! The frequency inverter may be connected to power supply every 60 s. This must be considered when operating a mains contactor in jog operation mode. For commissioning or after an emergency stop, a non-recurrent, direct restart is permissible.

After a failure and restoration of the power supply, the motor may start unexpectedly if the AutoStart function is activated.

If staff is endangered, a restart of the motor must be prevented by means of external circuitry.

Before commissioning and the start of the operation, make sure to fix all covers and check the terminals. Check the additional monitoring and protective devices according to EN 60204 and applicable the safety directives (e.g. Working Machines Act, Accident Prevention Directives etc.).

No connection work may be performed, while the system is in operation.

1.7 Maintenance and Service



Warning! Unauthorized opening and improper interventions can lead to personal injury or material damage. Repairs on the frequency inverters may only be carried out by the manufacturer or persons authorized by the manufacturer. Check protective equipment regularly.

2 System description

Positioning via motion blocks enables movement by a certain distance or to a target position. For each motion block, a separate motion profile can be set, including speed, acceleration and deceleration ramp. When motion blocks are processed automatically, the drive will react according to the parameterized behavior when it reaches the target position.

Scope of functions

- Positioning of linear and round axes
- Optimized round axes positioning (shortest way)
- Absolute and relative positioning
- Touch probe positioning for evaluation of sensors, e.g. motion as from this point
- Specification of values and parameter configuration can be done via user-defined scale (user units)
- 32 motion blocks for different target positions and motion profiles
- Automatic motion block sequence, event or time controlled
- Repetition of motion blocks
- Teach-in function for taking over the actual position value as the target position in the motion block
- JOG mode for manual operation via digital inputs
- Combination of positioning with electronic gear
- Different homing modes for determining the reference point for positioning
- Control via digital inputs or communication module
- Monitoring: Position monitoring via target window, contouring error monitoring, hardware and software limit switches
- Parameter configuration via commissioning and diagnosis software VPlus

Components required

Frequency inverter ACU (ACTIVE Cube),
Incremental encoder or resolver,
Suitable extension module,
Interface adapter KP232 for port (A),
Commissioning and diagnosis software VPlus, version 4 or higher

Optional Components

Communication modules (1 option possible),

Port (B):

CM-232 with RS232 interface,
CM-485 with RS485 interface,
CM-PDP-V1 with Profibus-DP-V1 interface,
CM-CAN with CANopen interface

Expansion modules (1 option possible), port (C):

EM-ENC for detailed evaluation of incremental encoder (TTL to RS-422A/RS-485 or HTL, DC 5 to 30 V),
EM-IO for additional analog and digital outputs; depending on module, system bus interface available, too,
EM-RES for resolver evaluation; depending on module, system bus interface available, too,
EM-SYS for communication via system bus

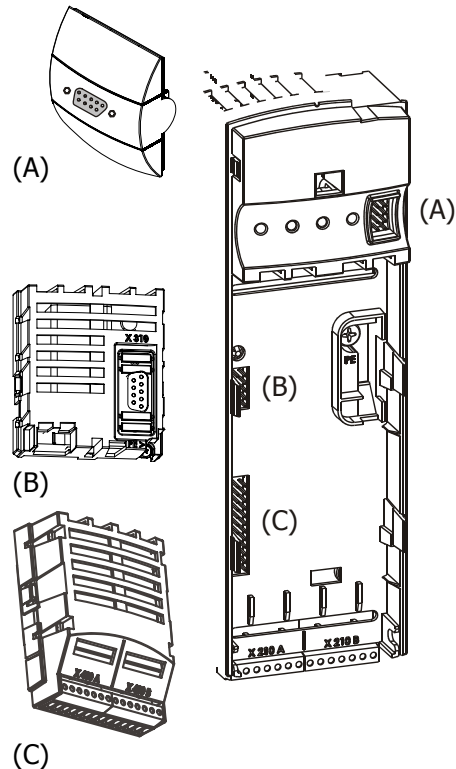

2.1 Terminal diagram ACTIVE Cube (ACU) series

The terminal diagram shows an example of a linear axis, with standard parameter configuration of digital inputs. The sensor is evaluated using an EM extension module.

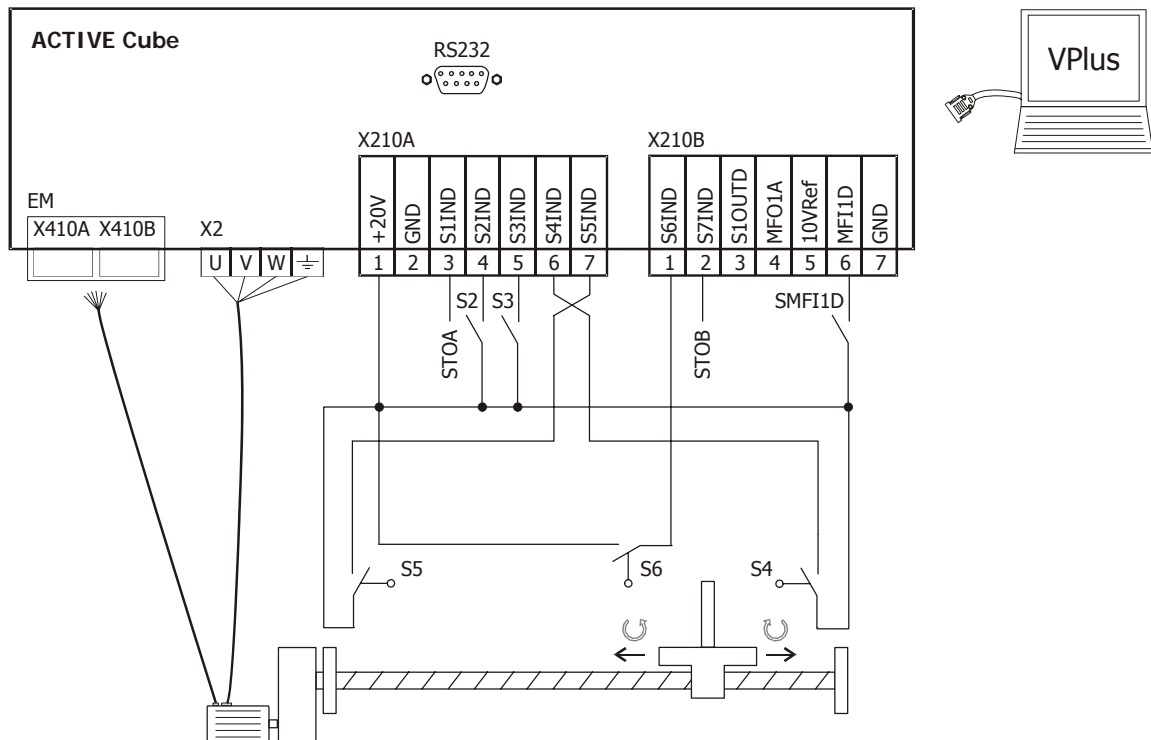

Terminal diagram ACTIVE Cube (ACU) series

↻: clockwise; ↺: Anticlockwise

Switch	Function
STOA	Wire input S1IND as shut-down path STOA of safety function STO ¹⁾
STOB	Wire input S1IND as shut-down path STOB of safety function STO ¹⁾
S2	Start positioning or clockwise operation in JOG mode
S3	Stop positioning or anticlockwise operation in JOG mode
S4	Limit switch for limitation of motion range in positive direction ²⁾
S5	Limit switch for limitation of motion range in negative direction ²⁾
S6	Home switch for homing, point of reference for absolute positioning
SMFI1D	Change-over between positioning mode and JOG mode (JOG mode in manual mode)

¹⁾ Safety function STO (Safe Torque Off) is wired through two channels via inputs STOA and STOB. This safety function is described in user manual "Safe Torque Off". The "Safe Torque Off" user manual must be complied with when using the "Safe Torque Off" function.

²⁾ Different from the factory setting. Assign S4IND and S5IND to the parameters for HW limit switches. Set Parameter *Operation mode* 490 of speed sensor 1 to „0 - Off“.

3 Commissioning of the Frequency Inverter



Warning! Carry out the electrical and mechanical installation according to the operating instructions or the "Quick Start Guide" of the frequency inverter. Comply with the safety instructions provided there.
Frequency inverters of the ACU series feature the "Safe Torque Off" function. In any case comply with the application manual "Safe Torque Off" when using this safety function.

3.1 Switching on Mains Voltage

After completion of the installation work, make sure to check all control and power connections again before switching on the mains voltage. If all electrical connections are correct, make sure that the frequency inverter is not enabled. After power-up, the frequency inverter carries out a self-test and the relay output (X10) reports "Fault".

Switch off release of frequency inverter:
Control inputs S1IND (STOA) and S7IND (STOB) open

After a few seconds, the self-test is complete, the relay (X10) picks up and signals "no fault".

If the unit is in "as-delivered" condition or after resetting the unit to the factory settings, the guided commissioning procedure is started automatically. On the control unit, the "SetUP" menu from the menu branch CTRL is displayed.

3.2 Commissioning of the motor



Caution! During the guided commissioning, comply with the safety instructions in chapter "General Safety Instructions and Information on Use" and in the Operating Instructions or the "Quick Start Guide" of the frequency inverter.

Carry out the guided commissioning procedure of the frequency inverter for one of the configurations listed below. These configurations contain the motion block positioning functions.

Note: The guided commissioning contains the function for parameter identification. The parameters are determined by way of measurement and set accordingly. In the case of higher requirements as regards the accuracy of the speed/torque control, you should carry out the guided commissioning procedure once again **under operating conditions** because part of the machine data depends on the operating temperature.

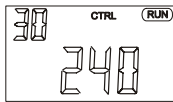

Configuration 240, field-orientated control with positioning

Configuration 240 extends the field-oriented control of an asynchronous machine by the positioning functions.

The motor controller and the position controller can use the same encoder (motor encoder) or different encoders (motor encoder and position encoder).

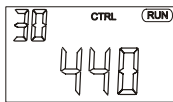

Configuration 440, sensorless field-orientated control with positioning

Configuration 440 extends the sensorless field-oriented control of an asynchronous machine by the positioning functions.

The motor is controlled without sensors. The positioning controller can be used via any encoder input.

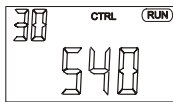

Configuration 540, field-orientated control of synchronous machine with positioning

Configuration 540 extends the field-oriented control of a synchronous machine by the positioning functions. Extension module EM-RES with resolver interface are required for this.

The motor controller and the position controller can use the same encoder (motor encoder) or different encoders (motor encoder and position encoder).



Caution! To enable control of a synchronous machine in configuration 540, parameter *Offset* **382** must be set before the guided commissioning. To do this, proceed according to the operating instructions for the extension module EM-RES installed. Otherwise, personal or machine damage may occur.

Note: For first commissioning, the drive can be controlled manually, using the JOG function, via the "FUN" key or the digital inputs. The processing speed of automatic motion block sequence can be reduced for commissioning. To do this, use the speed override function.

Note: The motor encoder should only be used for motor and position control in slip-free systems (e.g. linear spindle). In systems where slip may occur (e.g. wheel/rail systems) always use a position encoder to obtain optimum results.

3.3 Control Inputs and Outputs

The modular structure of the frequency inverters enables a wide spectrum of applications on the basis of the available hardware and software functionality. The functionality of the control inputs and outputs described in the "Quick Start Guide" and operating instructions is extended in the described configurations.



Caution! Switch off power supply before connecting or disconnecting the control inputs and outputs. Verify that the keyed control inputs and outputs are deenergized before connecting or disconnecting them. Otherwise, components may be damaged.
The unit may only be connected with the power supply switched off. Make sure that the frequency inverter is discharged.

ACU frequency inverters of ACTIVE Cube series

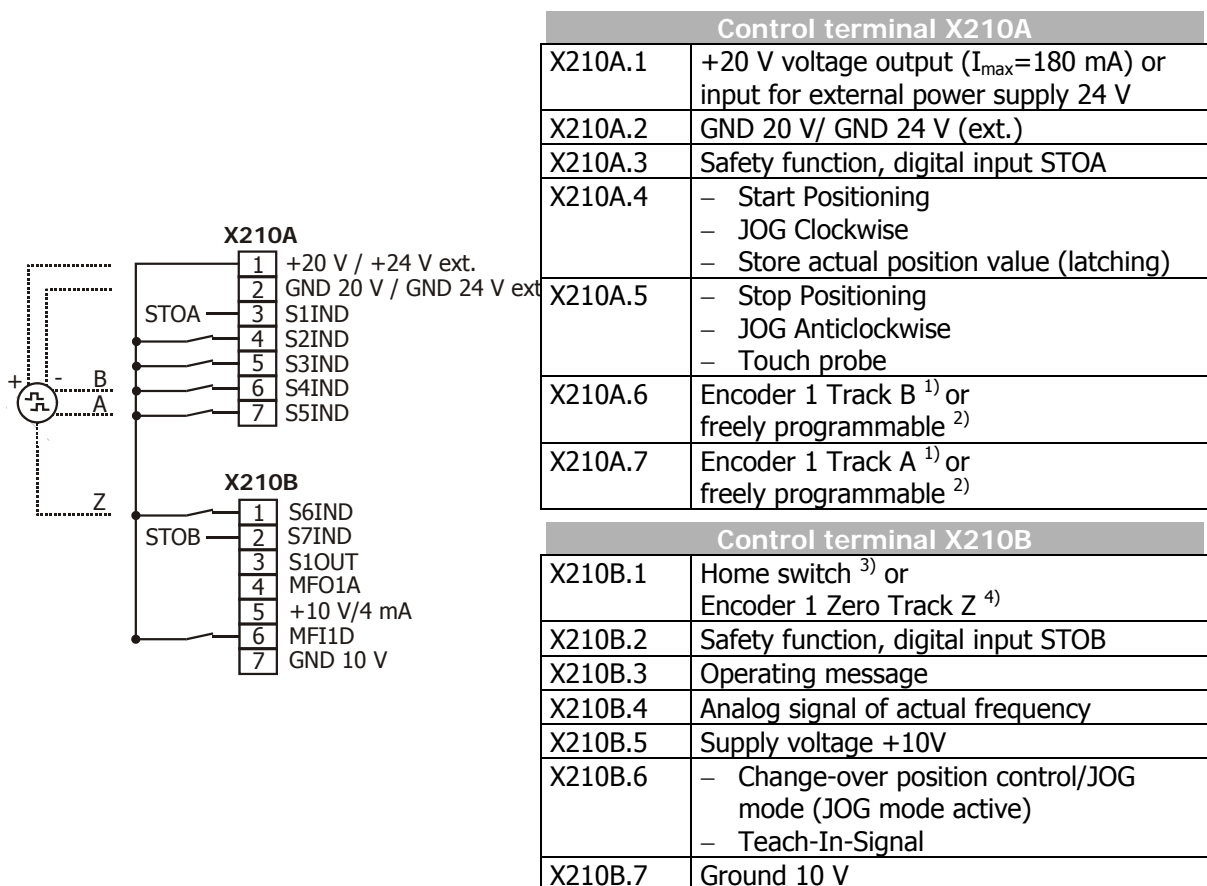

- 1) Factory setting in configuration 240
- 2) If no speed sensor is connected to S4IND/S5IND the digital inputs can be used freely programmable (e.g. for hardware limit switches).
- 3) Factory setting in configurations 240, 440 and 540
- 4) For evaluation of an encoder zero track an *Operation Mode 490* for speed sensor 1 higher than 1000 must be selected. Linking of other functions to this input are not active.

The connection diagram describes the default assignment of control terminals and functions in the different configurations positioning control. According to the requirements of the application, the other functions can be assigned to the control terminals.

Note: In order to fully use the positioning functions, an optional extension module is required. This module enables, for example, encoder evaluation, motion-block change-over or reference percentage change-over.

3.3.1 Factory settings of the digital inputs

Control input functions			
Digital Input	Control terminal	Control positioning	JOG mode / Teach-in
Digital inputs of frequency inverter:			
S1IND	X210A.3	Digital input STOA for safety function	
S2IND	X210A.4	Start Positioning	Store actual position value ³⁾ JOG Clockwise
S3IND	X210A.5	Stop Positioning, Touch probe ¹⁾	JOG Anticlockwise
S4IND	X210A.6	Freely programmable or Encoder 1 Track B ²⁾	
S5IND	X210A.7	Freely programmable or Encoder 1 Track A ²⁾	
S6IND	X210B.1	Home switch or Encoder 1 Zero Track Z ²⁾	
	X210B.2	Digital input STOB for safety function	
MFI1D	X210B.6	Change-over position control/JOG mode (JOG mode active)	Teach-in signal in teach-in mode
Digital inputs extension module:			
EM-S1IND	depending on module	Motion Block Change-Over 1 Alternative: - Encoder 2 Zero Track Z - Fixed frequency change-over 1 - Fixed percentage value change-over 1	
EM-S2IND		Motion Block Change-Over 2 Alternative: - Encoder 2 Track A - Fixed frequency change-over 2 - Fixed percentage value change-over 2	
EM-S3IND		Motion Block Change-Over 3 Alternative: - Encoder 2 Track B	

¹⁾ Comply with the notes in section 4.4.1.3.

²⁾ Dependent on the settings of parameters *Configuration 30* and *Operation Mode 490*. See chapter 3.5.1.4.

³⁾ Switch on the function via parameter *Operation Mode 1280*. Comply with the notes in section 4.13.

Control terminal/ Identification	Description
X210A.4 Start Positioning	The input is assigned to parameter <i>Start Positioning 1222</i> . When activated, the <i>Starting-Record Number 1228</i> or another motion block selected by the motion block change-over function is started. The motion blocks can be switched via digital inputs EM-S1IND, EM-S2IND and EM-S3IND of an extension module.
JOG Clockwise	In JOG mode, the drive is moved in positive direction (clockwise) at an adjustable fixed speed. JOG mode is activated via terminal X210B.6 . In teach-in operation modes (<i>Operation Mode 1221</i>), the JOG function is activated automatically.
Store actual position value	The function can be switched on via parameter <i>Operation Mode 1280</i> . With signal edge the actual position value is stored in the EEPROM and displayed via <i>Latched Position 1281</i> .

X210A.5

Stop Positioning

The drive stops at the current position at deceleration ramp set in *Deceleration 1206*.

JOG Anticlockwise

In JOG mode, the drive is moved in negative direction (anticlockwise) at an adjustable fixed speed. JOG mode is activated via terminal **X210B.6**. In teach-in operation modes (*Operation Mode 1221*), the JOG function is activated automatically.

Touch probe

Input for momentary contact switch or sensor for setting the reference position. Effective in *Motion Mode 1208* with touch-probe. Rising or falling edge (depending on setting of *Motion Mode 1208*) on input sets the point of reference at the current position. As soon as the signal is received, the drive moves by the relative distance of parameter *Target Position/Distance 1202*. Parameter configuration for digital signal "Stop Positioning" should be changed when touch probe mode is used.

X210A.6

Encoder 1

Input Encoder 1 Track B, HTL, DC 12 ... 30 V

or freely programmable

Evaluation of parameterized functions if the terminal is not used as encoder input.

Possible function: Pos. HW Limit Switch

Input for positive hardware limit switch. Limitation of travel range in positive direction. The drive reacts according to parameter *Fault Reaction 1143* when the switch is reached. Positive direction (clockwise direction) is disabled.

Set parameter *Pos. HW Limit Switch 1138* = "540 - S4IND inverted (Hardware)". Set Parameter *Operation Mode 490* of speed sensor 1 = "0 - Off". If X210A.6 is used as encoder input the HW limit switch function is not evaluated as this input.

X210A.7

Encoder 1

Input Encoder 1 Track A, HTL, DC 12 ... 30 V

or freely programmable

Evaluation of parameterized functions if the terminal is not used as encoder input.

Possible function: Neg. HW Limit Switch

Input for negative hardware limit switch. Limitation of travel range in negative direction. The drive reacts according to parameter *Fault Reaction 1143* when the switch is reached. Negative direction (anticlockwise direction) is disabled.

Set parameter *Neg. HW Limit Switch 1137* = "541 - S5IND inverted (Hardware)". Set Parameter *Operation Mode 490* of speed sensor 1 = "0 - Off". If X210A.7 is used as encoder input the HW limit switch function is not evaluated as this input.

X210B.1

Home switch

Input for reference cams. Marks the point of reference for absolute positioning. Via parameter *Home Switch 1139*, the logic status of the switch is evaluated.

or Encoder 1

Input Encoder 1 Zero Track Z, HTL, DC 12 ... 30 V.

Select one of the settings 1001 ... 1132 (with reference pulse) for parameter *Operation Mode 490*.

X210B.6

JOG-Mode Active

Activates JOG mode. JOG clockwise via terminal **X210A.4** or JOG anticlockwise via terminal **X210A.5** is executed.
In teach-in operation modes (*Operation Mode 1221*), the JOG function is activated automatically.

Teach-In

When a rising signal edge is received, the current position in the selected motion block is saved as the target position.
The motion block is selected by parameter *Starting-Record Number 1228* or the motion block change-over function (parameters **1224 to 1227** and **1254**).
The function is activated via *Operation Mode 1221*.
Parameter *Teach-In-Signal 1239* must be assigned the digital input signal or the logic signal which is to trigger saving of the actual position.

3.4 Digital inputs for speed sensor inputs or for other functions

The setting of parameter *Operation Mode 490* of speed sensor 1 affects the processing of functions which are linked to the digital inputs S4IND, S5IND and S6IND:

- In the settings 1 ... 132 for *Operation Mode 490* the digital inputs S4IND and S5IND are prepared for speed sensor inputs.
- In the settings 1001 ... 1132 for *Operation Mode 490* the digital inputs S4IND, S5IND and S6IND are prepared for speed sensor inputs.

The setting of the digital inputs as speed sensor inputs (1 ... 1132 for *Operation Mode 490*) has higher priority than the control of other functions via these inputs. Other functions will not be evaluated.

Set *Operation Mode 490* to "0 - Off" if S4IND, S5IND and S6IND shall not be used as speed sensor inputs but for control of other functions via these inputs.

Selection for <i>Operation Mode 490</i>	S4IND, S5IND and S6IND as speed sensor inputs or for other functions
0	Functions which are assigned to the digital inputs S4IND, S5IND and S6IND will be evaluated. The digital inputs S4IND, S5IND and S6IND are not prepared as speed sensor inputs.
1 ... 132	The digital inputs S4IND and S5IND are prepared as speed sensor inputs. Other functions which are assigned to the inputs S4IND and S5IND will not be evaluated.
1001 ... 1132	The digital inputs S4IND, S5IND and S6IND are prepared as speed sensor inputs. Other functions which are assigned to the inputs S4IND, S5IND and S6IND will not be evaluated.

For the settings of speed sensor inputs also refer to section 3.5.1.

3.5 Positioning - commissioning procedure

Terminal assignment:

S1IND (STOA) and S7IND (STOB): LOW signal
S2IND (Start positioning): LOW signal
S3IND (Stop positioning): LOW signal
S4IND and S5IND: encoder track B and track A or for parameterized function
S6IND: home switch or encoder zero track Z
MFI1D (JOG mode): LOW signal

Commissioning of frequency inverter:

Comply with chapter "Commissioning of Frequency Inverter",
set up configuration 240, 440 or 540,
switch on power supply,
start commissioning and diagnosis program VPlus (if not yet done for commissioning),
Set up reference system (motion distance per rotation of drive and gear factor),
Select suitable homing mode,
Select encoder source for positioning

For manual mode (JOG mode):

Set up parameters for JOG mode or use factory settings,
Release with HIGH signal on S1IND (STOA) and S7IND (STOB),
Activate JOG mode with HIGH signal at MFI1D, clockwise via S2IND, anticlockwise via S3IND, perform function test

Entering motion profile:

In VPlus, set up the parameters of the motion blocks,
switch on speed override, in order to position at reduced speed during commissioning.

Start positioning:

Check readiness for operation: when green LED is flashing: ready for operation; if green and red LED are flashing: ready for operation and warning message is present, repair fault,
Release with HIGH signal on S1IND (STOA) and S7IND (STOB) and start of positioning with HIGH signal on S2IND

For communication via field bus or system bus: Set up other parameters according to operating instructions of the corresponding extension or communication module.

Motion blocks

The motion profile is defined in motion blocks, indicating the target position, speed and acceleration. A positioning operation may comprise a maximum of 32 motion blocks.

Discrete selection: Each of the 32 motion blocks can be selected both via logic signals and parameters (also for transfer via field bus or system bus).

Cycle: The motion blocks can be repeated or processed in a freely programmable order.

In the motion blocks, the motion block to be processed next can be identified.

The next motion block can be activated:

- by events, e.g. via digital inputs or logic signals
- after a definable delay

In the motion block, the motion mode is selected: absolute (referred to a fixed reference position), relative (to moving distance, referred to last position approached) or "Touch Probe" (to moving distance, referred to a sensor signal on digital input S3IND).

Digital signals for status indication

Digital signals can be influenced depending on the status of a motion order. For example, a digital signal can be parameterized such that it signals reaching of the target position or the end of the motion block.

JOG mode

The drive is operated manually via two digital inputs at a parameterizable, fixed speed. This enables for example functional tests for commissioning and approaching of positions for teach-in mode.

Teach-In

With this function, any position approached can be entered directly in a motion block as a target position. The required position can be approached in JOG mode. The current position value is saved as the target position when an increasing edge is present on the teach-in terminal.

Homing

To determine the drive speed and position, the frequency inverter captures the signals from position sensors such as incremental encoders or resolvers. When the frequency inverter is switched on, there is no relation between the position sensor and the mechanical position of the axis. In order to determine an absolute point of reference (reference position) for the positioning operation, a homing operation must be performed. All absolute position data is referred to this reference position. By selecting a certain homing mode, you can define in which direction the reference position is to be found and which type of switch (limit switch, home switch) is used. In the homing operation, the drive moves to the reference position and stops there.

Monitoring

To limit the motion range and protect the machine, limit switches are connected to the digital input terminals of the frequency inverter. The behavior of the drive when reaching the limit switches is parameterizable (e.g. error switch-off, shut down).

Software limit switches enable monitoring of the permissible motion range. Positioning commands will be executed only within the range defined by parameters. The software limit switches are active only after a successful homing operation.

The adjustable target window monitors the current position after performance of a positioning operation. Reaching of the required position is signaled only if the current position is within the target window.

The contouring error monitoring function monitors the maximum permissible deviation of the current position and the required position. This monitoring function determines how accurately the positioning operation must be performed.

3.5.1 Getting started

In order to use the positioning function, you must start the frequency inverter in Configuration 240, 440 or 540. If required, perform a motor measurement. Several functions will be readjusted as soon as you set up the configuration of the positioning operation. This includes the functions of the digital inputs.

Warning! Ensure that your parameterization corresponds to the connected terminals.

For commissioning, you must select different configurations for the following cases:

Case	Description	Possible Configuration 30
1	Motor encoder is position encoder at the same time	240, 540
2	Two different encoders for motor and positioning	240, 540
3	No motor encoder, external encoder for positioning	440

3.5.1.1 Motor encoder is position encoder at the same time

In slip-free systems, the motor encoder can be used as position encoder at the same time. By using one encoder for both functions, the overall costs can be reduced.

Configuration 30 = 240 540, motor encoder = position encoder		
Encoder 1	Encoder 2	Motor controller
Operation Mode 490	Operation Mode 493	Actual Speed Source 766
Division Marks 491	Division Marks 494	Actual Position Source 1141 = "0 - As P. 766 Actual Speed Source"
	Level 495	

In the corresponding parameters, set up the properties of the encoders according to the wiring of Encoder 1 or Encoder 2. The parameters of Encoder 2 are available only if the corresponding extension module is connected.

Adjust parameter *Actual Speed Source* **766** to connected encoder.

Adjust parameter *Actual Position Source* **1141** to "0 - As P. 766 Actual Speed Source" (corresponds to factory settings).

3.5.1.2 Two different encoders for motor and positioning

In systems where slip may occur, the motor encoder cannot be used as position encoder at the same time. Due to the slip (e.g. slipping in the case of a wheel/rail system), the motor encoder cannot approach the actual target with sufficient accuracy. By using a position encoder connected to the positioning system, precise positioning is possible even in the case of a system where slip may occur. The corresponding configurations are described in the following tables. In any case, you will need a suitable extension module for evaluation of Encoder 2.

Note: If both a motor and a position encoder are used, the function "Electronic Gear" cannot be used.

**Encoder 1 is motor encoder
Encoder 2 is position encoder**

<i>Configuration 30 = 240 540, motor encoder, position encoder</i>			
Encoder 1	Encoder 2	Motor controller	Position controller
<i>Operation mode</i> 490	<i>Operation mode</i> 493	<i>Actual Speed Source</i> 766 = "1 – Speed Sensor 1"	<i>Actual Position Source</i> 1141 = "2 – Speed Sensor 2"
<i>Division Marks</i> 491	<i>Division Marks</i> 494		
	<i>Level</i> 495		

**Encoder 1 is position encoder
Encoder 2 is motor encoder**

<i>Configuration 30 = 240 540, position encoder, motor encoder</i>			
Encoder 1	Encoder 2	Motor controller	Position controller
<i>Operation mode</i> 490	<i>Operation mode</i> 493	<i>Actual Speed Source</i> 766 = "2 – Speed Sensor 2"	<i>Actual Position Source</i> 1141 = "1 – Speed Sensor 1"
<i>Division Marks</i> 491	<i>Division Marks</i> 494		
	<i>Level</i> 495		

In the corresponding parameters, set up the encoders parameters according to the properties of Encoder 1 or Encoder 2. The parameters of Encoder 2 are available only if the corresponding extension module is connected.

Adjust parameter *Actual Speed Source* **766** to connected motor encoder. The external encoder is evaluated via parameter *Actual Position Source* **1141**.

3.5.1.3 No motor encoder, external encoder for positioning

In some applications the speed control accuracy and the dynamic behaviour of a sensorless motor control are sufficient. Positioning is possible in non-slip and in slip-containing systems via an external encoder.

<i>Configuration 30 = 440, only position encoder</i>			
Encoder 1	Encoder 2	Motorregler	Position controller
<i>Operation mode</i> 490	<i>Operation mode</i> 493	<i>Actual Speed</i> <i>Source 766 = 3 -</i> <i>Machine Model</i>	<i>Actual Position</i> <i>Source 1141 =</i> <i>"1 - Speed Sensor 1"</i> <i>or "2 - Speed Sensor</i> <i>2", depending on</i> <i>the application</i>
<i>Division Marks</i> 491	<i>Division Marks</i> 494		
	<i>Level</i> 495		

Set the encoder behaviour in the correlative parameters for speed sensor 1 and speed sensor 2. The speed sensor 1 parameters are only available if an expansion module with speed sensor input is installed.

3.5.1.4 Consider the operation mode settings for speed sensor input

The digital input signals S4IND, S5IND and S6IND can set as signal sources in all configurations (parameter *Configuration 30*).

- In parameter settings *Operation Mode 490* > 0 the inputs S4IND and S5IND are evaluated only as speed sensor inputs. Other functions at these inputs are not evaluated.
- In parameter settings *Operation Mode 490* > 1000 additional the input S6IND is evaluated as speed sensor track. Other functions at this input are not evaluated.

Digital inputs	<i>Operation Mode 490 =</i>		
	1001 ... 1132	1 ... 1000	0
S4IND	Speed sensor 1 track B		Free programmable
S5IND	Speed sensor 1 track A		Free programmable
S6IND	Speed sensor 1 track Z	Home switch	

3.5.2 Reference system

The reference system provides the link between the electrical system and the mechanical system. In parameter *Feed Constant 1115*, the user units (u) per revolution (U) are entered. By choosing a suitable parameter configuration, the feed constant can consider both the mechanical motion distance and the accuracy (resolution) (see example).

Via *Gear Box: Driving shaft revolutions 1116* and *Gear Box: Motor shaft revolutions 1117*, it is possible to consider the transmission ratio of a gearbox.

The terms *Gear Box: Driving shaft revolutions 1116* and *Gear Box: Motor shaft revolutions 1117* are used in compliance with CANopen Standard CiA402 *Device Profile Drives and Motion Control*.

Parameter		Settings		
No.	Description	Min.	Max.	Fact. sett.
1115	Feed constant	1 u/U	$2^{31}-1$ u/U	65536 u/U
1116	Gear Box: Driving shaft revolutions	1	65 535	1
1117	Gear Box: Motor shaft revolutions	1	65 535	1

Maximum motion distance

The internal representation of position values is limited to $\pm 2^{31}-1$ increments, referred to a resolution of 2^{16} increments/revolution. The maximum motion distance s_{\max} depends on the settings of parameters *Feed Constant 1115*, *Gear Box: Driving shaft revolutions 1116* and *Gear Box: Motor shaft revolutions 1117*. At a higher accuracy of the feed constant and gear factor, the maximum motion distance is reduced.

$$s_{\max}[\text{u}] = \frac{\pm (2^{31} - 1) \text{Ink} \cdot \text{Feed Constant } 1115 \frac{[\text{u}]}{\text{U}} \cdot \text{Gear Box : Driving shaft revolutions } 1116}{2^{16} \frac{\text{Ink}}{\text{U}} \cdot \text{Gear Box : Motor shaft revolutions } 1117}$$

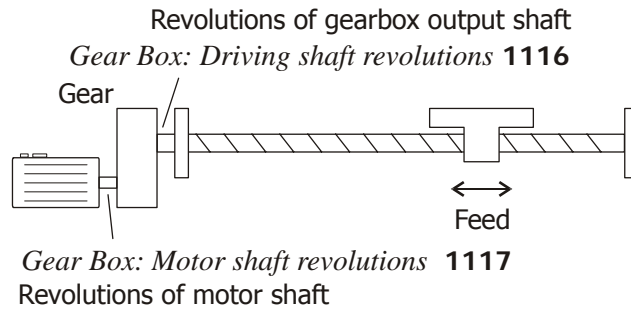
Example: Linear axis, drive via gearbox

Feed rate of linear axis: 25 mm per revolution of the output shaft
 Required positioning accuracy: $\pm 1/100$ mm
 Gear factor: 1/19.75

$$\text{Feed Constant} = \frac{\text{Feed rate}}{\text{Accuracy}} = \frac{25 \text{ mm}}{1/100 \text{ mm}} = 2500 \quad 1 \text{ unit} = 0.01 \text{ mm}$$

Set *Feed Constant 1115* to 2500 u/U.

$$\text{Gear factor} = \frac{1}{19.75} = \frac{\text{Gear Box : Shaft revolutions } \mathbf{1116}}{\text{Gear Box : Motor revolutions } \mathbf{1117}} = \frac{100}{1975}$$

Set *Gear Box: Driving shaft revolutions 1116* to 100.

Set *Gear Box: Motor shaft revolutions 1117* to 1975.

$$s_{\max} [u] = \frac{\pm (2^{31} - 1) \text{Ink} \cdot 2500 \frac{[u]}{U} \cdot 100}{2^{16} \frac{\text{Ink}}{U} \cdot 1975} = \pm 4\,187\,848 \text{ units} \approx \pm 41\,878 \text{ mm} \approx \pm 41.9 \text{ m}$$

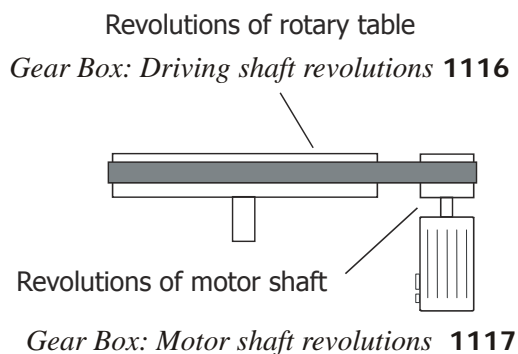
Example: Rotary table

Turning angle (feed) of rotary table: 360°
 Required positioning accuracy: $\pm 1/10^\circ$
 Gear factor (Ratio of belt drive wheel diameters): 2.45 m/0.18 m

$$\text{Feed Constant} = \frac{\text{Feed rate}}{\text{Accuracy}} = \frac{360^\circ}{1/10^\circ} = 3600$$

Set *Feed Constant 1115* to 3600 u/U.

$$\text{Gear Factor} = \frac{2.45}{0.18} = \frac{\text{Gear Box : Driving shaft revolutions } \mathbf{1116}}{\text{Gear Box : Motor shaft revolutions } \mathbf{1117}} = \frac{245}{18}$$

Set *Gear Box: Driving shaft revolutions* **1116** to 245.

Set *Gear Box: Motor shaft revolutions* **1117** to 18.

$$s_{\max} [u] = \frac{\pm (2^{31} - 1) \text{Ink} \cdot 3600 \frac{[u]}{U} \cdot 245}{2^{16} \frac{\text{Ink}}{U} \cdot 18} = \pm 1\,605\,631\,999 \text{ units} \approx \pm 160\,563\,200^\circ \approx \pm 446\,009 \text{ U}$$

Note: Gear transmission factors are rounded in many cases and may result in a "drift" in the application, i.e. due to the rounded values, the deviation between the actual position and the required position increases with each revolution. This particularly affects rotary table applications which turn in one direction continuously because their position change continues to increase all the time. Use exact gear transmission factors in order to eliminate this drift. The exact gear transmission factor can be calculated from the number of teeth of the individual gearwheels.

Example: Calculation of gear factors

Example: Three-stage gearbox
($i = 67.7$ rounded) at reduction
gearing of 3:1.

Number of teeth:

D1 = 13	D2 = 25
D3 = 12	D4 = 27
D5 = 11	D6 = 31
V1 = 1	V2 = 3

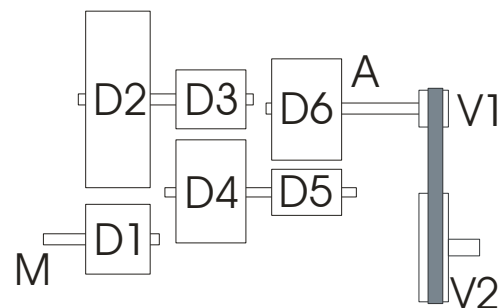

M: motor side, A: output side, V: reduction gearing

$$\begin{aligned} \text{Gear Box: Driving shaft revolutions } \mathbf{1116} &= D2 \times D4 \times D6 \times V2 \\ &= 25 \times 27 \times 31 \times 3 = \underline{\underline{62775}} \end{aligned}$$

$$\begin{aligned} \text{Gear Box: Motor shaft revolutions } \mathbf{1117} &= D1 \times D3 \times D5 \times V1 \\ &= 13 \times 12 \times 11 \times 1 = \underline{\underline{1716}} \end{aligned}$$

3.5.3 Setting up a motion profile

For complex motion profiles, e.g. profiles requiring different speeds and accelerations, different motion blocks must be created.

Example:

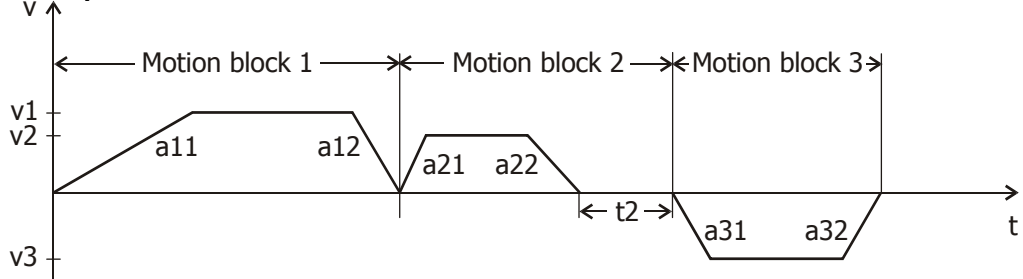

Motion block 1		Motion block 2		Motion block 3	
Approach target pos. 1		Approach target pos. 2		Return	
a11	Acceleration	a21	Acceleration	a31	Acceleration
v1	Speed	v2	Speed	v3	Speed
a12	Deceleration	a22	Deceleration	a32	Deceleration
		t2	Delay until next motion block, e.g. for work-piece machining		

Motion block parameters	In example above:
<i>Target Position / Distance</i> 1202	s1, s2, s3
<i>Speed</i> 1203	v1, v2, v3
<i>Acceleration</i> 1204	a11, a21, a31
<i>Deceleration</i> 1206	a12, a22, a32
<i>Delay</i> 1212	t2
<i>Delay: Next Motion Block</i> 1213	3 (motion block 2)
<i>Event 1</i> 1214	6 – On (motion block 1)
<i>Event 1: Next Motion Block</i> 1214	2 (motion block 1); 0 (motion block 3);

The motion profile shown in the example requires parameterization of 3 motion blocks.

3.5.4 Control via software

All parameters of the frequency inverter can be set up via the PC software VPlus. In *Configuration 30*, set up an operation mode x40 which is suitable for positioning. Now, when data are read from the inverter, all parameters are read and are available for parameterization.

With the PC software VPlus, 32 motion blocks with different motion profiles are available. The program VTable which is included in VPlus enables comfortable parameterization of the motion blocks. The program can be started via menu entry "Start Positioning" or the "Positioning Function" icon. VTable represents the 32 motion blocks arranged in columns, which provides better clarity. Via index 0, values can be changed for all motion blocks at the same time. This can be used, for example, to change the speed in all motion blocks quickly and comfortably.

VTable			
Motion Blocks	Index 0	Index 1	Index 2
1202 Target Position / Distance		0 units	4096 units
1203 Speed		10000 u/s	20000 u/s
1204 Acceleration		100000 u/s ²	100000 u/s ²
1205 Ramp Rise Time		500 ms	500 ms
1206 Deceleration		100000 u/s ²	327680 u/s ²
1207 Ramp Fall Time		500 ms	500 ms
1208 Motion Mode		0 - absolute	0 - absolute
1209 Touch-Probe-Window		65536 units	65536 units
1210 Touch-Probe-Error: Next M...		-2	-2
1211 No. of Repetitions		0	0
1212 Delay		0 ms	0 ms
1213 Delay: Next Motion Block		0	0
1214 Event 1		75 - S6IND	275 - S6IND inverted
1215 Event 1: Next Motion Block		2	3
1216 Event 2		7 - Off	7 - Off
1217 Event 2: Next Motion Block		0	0
1218 Digital Signal 1		12 - Start: off Ref.reached: on End: ---	0 - Start: --- Ref.reached: --- End: ---
1219 Digital Signal 2		0 - Start: --- Ref.reached: --- End: ---	0 - Start: --- Ref.reached: --- End: ---
1247 Digital Signal 3		0 - Start: --- Ref.reached: --- End: ---	0 - Start: --- Ref.reached: --- End: ---
1248 Digital Signal 4		0 - Start: --- Ref.reached: --- End: ---	0 - Start: --- Ref.reached: --- End: ---
1260 Interrupt-Event 1		7 - Off	7 - Off
1261 Int.-Event 1: Eval.-Mode		1 - Level-Controlled	1 - Level-Controlled
1262 Int.-Event 1: Next Motion BL...		0	0
1263 Interrupt-Event 2		7 - Off	7 - Off
1264 Int.-Event 2: Eval.-Mode		1 - Level-Controlled	1 - Level-Controlled
1265 Int.-Event 2: Next Motion BL...		0	0

3.5.5 Write index and read index for the motion blocks table

Via the write and read indices, the index of the motion block table the parameters of which are to be read or written is specified. VTable uses the parameters automatically for writing and reading. The write and read parameters are required for parameterization via keypad or for parameterization via a bus system (e.g. PROFIBUS).

Parameterize and read motion blocks with write index and read index via software VPlus

The motion blocks can be parameterized in the user interface VPlus or in the motion block table VTable. In the user interface VPlus, an index of the motion block table can be set via parameter *Motion Block Sel. (Writing)* **1200**. The chosen index corresponds to a column in the motion block table. The settings of parameters **1202** to **1219**, **1247** and **1248** are taken over in the selected index of the motion block table. Via parameter *Motion Block sel. (Reading)* **1201**, the values of a selected index can be read from the motion block table.

Parameter		Settings		
No.	Description	Min.	Max.	Fact. sett.
1200	Motion Block Sel. (Writing)	0	65 ¹⁾	1
1201	Motion Block Sel. (Reading)	0	65 ¹⁾	1

¹⁾ Setting defines the place where motion blocks are saved.

Settings for fixed parameterization (non-volatile):

0: all motion blocks in EEPROM

1 ... 32: individual motion blocks in EEPROM

Settings only required for parameterization via communication interface (volatile):

33: all motion blocks in RAM

34 ... 65: individual motion blocks in RAM

Note: The settings "0" and "33" for *Motion Block Sel. (Writing)* **1200** change all motion blocks in EEPROM and RAM.

In the case of non-volatile storage (0...32), the changed values are still available when power supply is switched on again.

In the case of volatile storage (33...65), the data is only stored in RAM. If the unit is switched off, this data is lost and the data required are loaded from EEPROM after restart.

Definition:

Motion block RAM = Motion block EEPROM +33

Write index/Motion Block Sel. (Writing) 1200,
Read index/Motion Block Sel. (Reading) 1201

VPlus	
Parameter	Data Set 0
<i>Motion Block Sel. (Writing) 1200</i>	2
<i>Motion Block Sel. (Reading) 1201</i>	2
<i>Target Position / Distance 1202</i>	4096 units
<i>Speed 1203</i>	20000 u/s
.	...
.	...

VTable		
Motion Blocks	Index 1	Index 2
<i>Target Position / Distance 1202</i>	...	4096 units
<i>Speed 1203</i>	...	20000 u/s
.
.

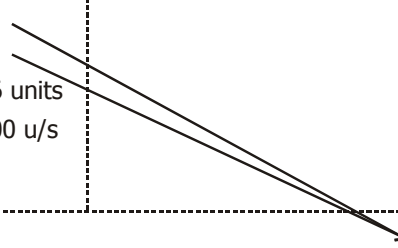

4 Operation Modes of the Positioning

4.1 General Issues about Operation Modes

The following operation modes are available for positioning. Operation modes:

- **Positioning mode.** Automatic operation for sequence-controlled and repeatable approach to different targets in an application. The target can be selected via an overriding controller (parameter channel of field bus or digital inputs).
- **Homing.** A homing operation is performed in order to define a new point of reference in the system. After a homing operation, the identified point of reference is used as the basis of all positioning operations.
- **JOG mode.** This operation mode enables free moving via digital inputs. This mode is often used for setup or service purposes.
- **Teach-in mode.** Teach-in mode is normally used only during first commissioning of a plant or after the plant has been retrofitted. In this mode, a current position can be saved for a motion block in the frequency inverter.

"Positioning Mode" and "Teach-In Mode" are selected via parameter *Operation Mode 1221*. "Homing Mode" is activated either automatically or manually. "JOG Mode" is activated via a digital input which deactivates "Positioning Mode".

4.1.1 Assignment of digital inputs

In the individual operation modes of the positioning, the digital inputs have different inputs. The following table provides an overview of the functions and assigns them to the terminals, as parameterized in the factory settings for the functions. Assignment of terminals S4IND/S5IND depends on *Configuration 30*.

	Function			
	Positioning	JOG mode	Homing	Teach-In
<i>Operation mode</i> 1221 =	1xx, 2xx	1xx, 2xx	1xx, 2xx	30x
Terminal				
S2IND	<i>Start Positioning</i> 1222	<i>Jog Clockwise</i> 1232	<i>Start Positioning</i> 1222	<i>Jog Clockwise</i> 1232
S3IND	<i>Stop Positioning</i> 1223 Touch probe ¹⁾	<i>Jog Anticlockwise</i> 1233	"0"	<i>Jog Anticlockwise</i> 1233
S4IND		30 = 440, 540	Free programmable, e.g. for <i>Positive HW Limit Switch 1138</i> ²⁾	
S5IND		30 = 240	Encoder track A	
		30 = 440, 540	Free programmable, e.g. for <i>Negative HW Limit Switch 1137</i> ²⁾	
		30 = 240	Encoder track B	
S6IND			<i>Home Switch</i> 1139	
MFI1D	"0"	"1"		<i>Teach-In Signal</i> 1239

¹⁾ Deactivate function "Stop Positioning" at S3IND if "Touch Probe" mode is used in the motion sequence. For parameter *Stop Positioning 1223*, you can also select any other digital input.

²⁾ Assign S4IND and S5IND to the inputs for HW limit switches. Parameterized functions will be evaluated only if the inputs are not used as encoder inputs. For evaluation as break contacts, you can assign inverted inputs to the parameters for the HW limit switches, e.g. *Positive HW Limit Switch 1138* = "540 - S4IND inverted (Hardware)". This can be used for wire-break monitoring.

Note: For controller release of the power component, wiring of the following digital inputs is required:
STOA (terminal X210A.3) and STOB (terminal X210B.2).

In safety-oriented systems, the documentation "Safe Torque Off" shall be complied with.

4.1.1.1 Instructions on MFI1D (multifunction input)

Multi-function input MFI1D is processed, depending on the application or function, as an analog input value or a digital input signal. By default, the positioning function uses multi-function input MFI1D as a digital signal for certain functions.

The sampling rate of multi-function input MFI1D is slower than that of digital signals S1IND, S2IND, etc. For this reason, this input should only be used for signals which are not time-critical, e.g. signal for activation of JOG mode.

Note: Do not use multi-function input MFI1D as an input for limit switches or reference cams. For limit switches and reference cams, use digital inputs S2IND ... S6IND or the digital inputs EM-SxIND of an extension module.

4.1.2 Operation modes for controlling the positioning operation

Parameter *Operation mode 1221* defines:

- Selection of starting record number via parameters or digital inputs
- Automatic sequence of motion orders or individual order
- Start of teach-in mode

<i>Operation mode 1221</i>	Function
0 - Off	No positioning.
101 - Sequence Mode w/o Restart, 1st Motion Block via Digital Inputs	Signal on <i>Start Positioning 1222</i> starts the positioning operation with the motion block selected with the digital inputs of motion block change-over. When the target position is reached, the settings for delay, event and next motion block are evaluated. If 0 is determined as the next motion block, the sequence is complete. The target position is maintained after the end of the automatic sequence.
102 - Sequence Mode w/o Restart, 1st Motion Block via P. 1228	Signal on <i>Start Positioning 1222</i> starts the positioning operation with the motion block set in parameter <i>Starting Record Number 1228</i> . When the target position is reached, the settings for delay, event and next motion block are evaluated. If 0 is determined as the next motion block, the sequence is complete. The target position is maintained after the end of the automatic sequence.
111 - Sequence Mode with Restart, 1st Motion Block via Digital Inputs	Signal on <i>Start Positioning 1222</i> starts the positioning operation with the motion block selected with the digital inputs of motion block change-over. When the target position is reached, the settings for delay, event and next motion block are evaluated. If 0 is determined as the next motion block, the sequence is complete. When the last motion block position is reached, the sequence is started with the 1 st motion block automatically.
112 - Sequence Mode with Restart, 1st Motion Block via P. 1228	Signal on <i>Start Positioning 1222</i> starts the positioning operation with the motion block set in parameter <i>Starting Record Number 1228</i> . When the target position is reached, the settings for delay, event and next motion block are evaluated. If 0 is determined as the next motion block, the sequence is complete. When the last motion block position is reached, the sequence is started with the 1 st motion block automatically.
201 - Single Motion, Motion Block Sel. via Digital Inputs	Signal on <i>Start Positioning 1222</i> starts the positioning operation with the motion block selected with the digital inputs of motion block change-over. After completion of the motion, the target position is maintained.
202 - Single Motion, Motion Block Sel. via P. 1228	Signal on <i>Start Positioning 1222</i> starts the positioning operation with the motion block set in parameter <i>1228 Starting Record Number</i> . After completion of the motion, the target position is maintained.
301 - Teach-In, Motion Block Sel. via Digital Inputs	Signal on <i>Teach-In Signal 1239</i> enters the current position in the motion block as the <i>Target Position / Distance 1202</i> . The motion block for entering the position is selected via the motion block change-over digital inputs. The JOG function is activated automatically. Move to position to be saved via digital inputs for parameters <i>Jog Clockwise 1232</i> and <i>Jog Anticlockwise 1233</i> (factory settings S2IND and S3IND).
302 - Teach-In, Motion Block Sel. via P. 1228	Signal on <i>Teach-In Signal 1239</i> enters the current position in the motion block as the <i>Target Position / Distance 1202</i> . The motion block for entering the position is selected via parameter <i>Starting Record Number 1228</i> . The JOG function is activated automatically. Move to position to be saved via digital inputs for parameters <i>Jog Clockwise 1232</i> and <i>Jog Anticlockwise 1233</i> (factory settings S2IND and S3IND).
1000 - Control by Function Table	The function (operation mode 5xx) which is selected for parameter <i>FT-instruction 1343</i> in the function table is executed. Also refer to the application manual "Function Table".

<p><i>Operation mode 1221</i></p> <p>10x</p>	<p><u>Sequence mode without restart</u></p> <p>Parameter <i>Operation mode 1221</i> = 101 or 102</p>
<p>11x</p>	<p><u>Sequence mode with restart</u></p> <p>Parameter <i>Operation mode 1221</i> = 111 or 112</p>
<p>20x</p>	<p><u>Single motion</u></p> <p>Parameter <i>Operation mode 1221</i> = 201 or 202</p>
<p>30x</p>	<p><u>Teach-In</u></p> <p>Parameter <i>Operation mode 1221</i> = 301 or 302</p>

4.1.3 Input and output signals

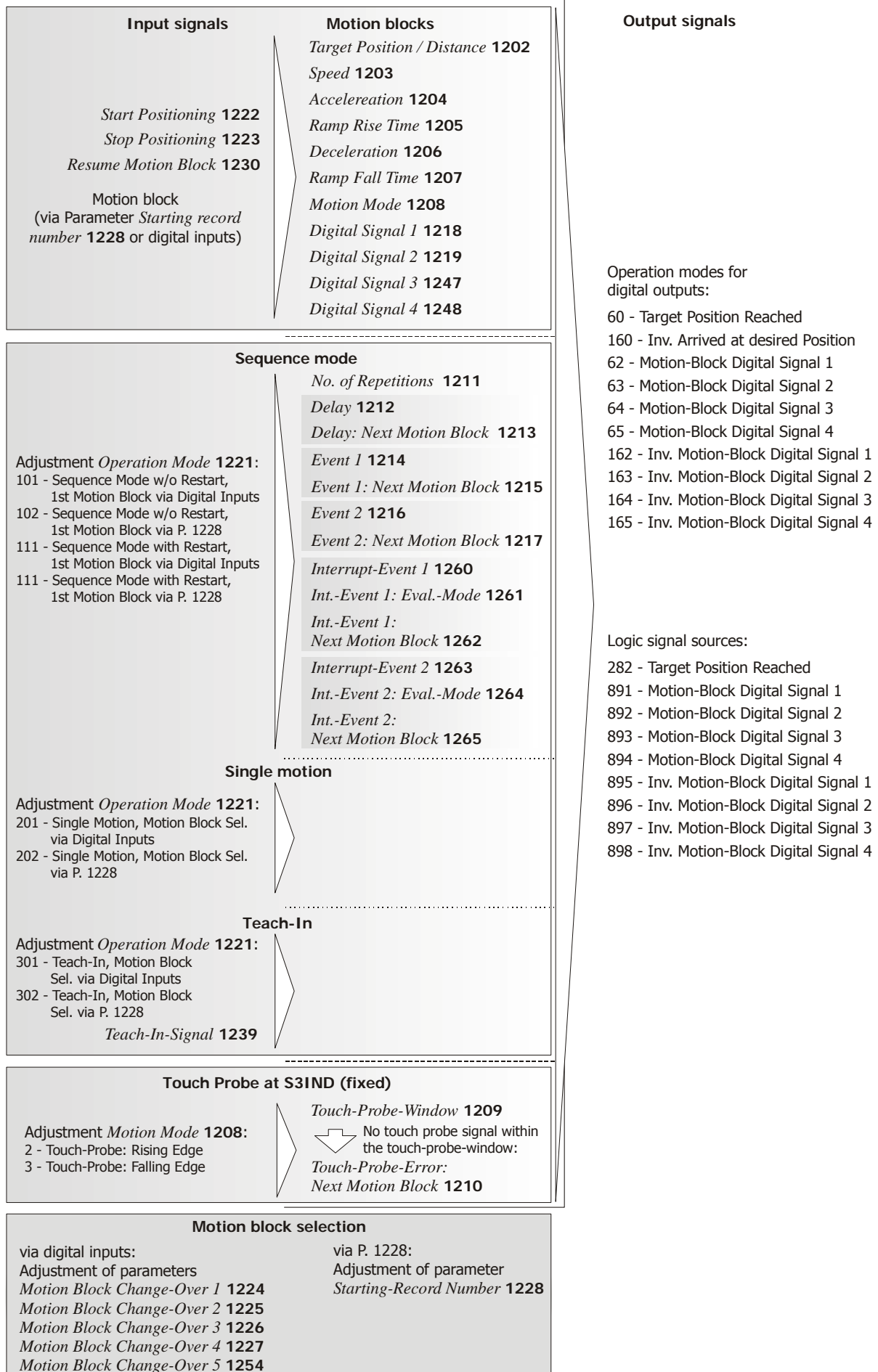

Note: Before a positioning operation can be started, the point of reference of the positioning operation must be determined in a homing operation. Otherwise, error message "F1570 – No Homing Done" will be displayed if you try to start a positioning operation.

4.2 Homing

When the drive is started, a defined starting position must be specified. In a homing operation, the point of reference of the positioning operation is determined. All positioning data relates to this point of reference. Once the homing operation is started, the drive moves until it reaches a home switch or limit switch and stops there. The limit switches limit the motion path. The direction of movement (search direction) at the start of the homing operation is defined by the homing mode. Additionally, the reaching of a limit switch will change the direction of the drive (dependent on the homing mode). The limit switches can also be used as the point of reference. For a list of homing modes, refer to chapter "List of Homing Modes".

Homing can be started:

- via a digital input
- by a control word via system bus or field bus ¹⁾
- automatically before the start of a motion block positioning operation

¹⁾ Extension module with system bus or field bus interface required

4.2.1 Automatic of manual start of homing

Use parameter *Start Homing (manual)* **1235** to start homing manually via a logic signal, e.g. via a digital input. The signal must be present until completion of the homing operation is signaled by logic signal "59 – Homing Done". If the start signal is reset during a homing operation, the drive will be stopped. Homing is not completed and positioning is not possible.

The homing start condition is defined by parameter *Operation Mode* **1220**.

<i>Operation mode</i> 1220		Function
1 -	manual	Start of homing via parameter <i>Start Homing (manual)</i> 1235 . For manual start of homing, the parameter must be assigned a logic signal or a digital input.
2 -	automatic	Factory setting. Automatic start of homing if controller is released and signal is present on <i>Start Positioning</i> 1222 . Automatic homing is performed only if the drive has not been referenced yet. Controller release via digital inputs S1IND (STOA) and S7IND (STOB).

4.2.2 Input and output signals for homing

Terminal assignment for homing						
Function	Con- troller release	<i>Start Homing (manual)</i> 1235 ¹⁾	<i>Stop Positio- ning</i> 1223	<i>Home Switch</i> 1139 ²⁾	<i>Neg. HW Limit Switch</i> 1137	<i>Pos. HW Limit Switch</i> 1138
		Off*	S3IND*	S6IND* ⁶⁾	S5IND ⁶⁾	S4IND ⁶⁾
Drive disabled	0	X	X	X	0 (1)	0 (1)
Homing is started	1	1	0	0	0 (1)	0 (1)
Home position is set	1	1	0	edge ³⁾	0 (1)	0 (1)
Homing is interrupted	1	1	1	X	0 (1)	0 (1)
Error message, limit switch as make contact function (<i>brake contact function</i>)						
F1445 ⁵⁾	X	X	X	X	1 (0)	1 (0)
F1447 (F1446) ⁵⁾	X	X	X	X	0 (1)	1 (0) ⁴⁾
F1448 (F1446) ⁵⁾	X	X	X	X	1 (0) ⁴⁾	0 (1)

0 = Low / 1 = High / X = any / * = factory setting

¹⁾ **Start Homing:** Homing is started automatically if required (drive not yet referenced) in parameter configuration *Operation Mode* **1220** = "2 – automatic". In parameter configuration *Operation Mode* **1220** = "1 – manual", the digital signal *Start Homing (manual)* **1235** must be present.

²⁾ **Home switch:** The home switch can be a reference cam, a limit switch or the zero pulse of an encoder. Also refer to the descriptions of the individual homing modes (parameter *Homing Mode* **1130**) in section 5.

³⁾ **Edge:** The rising or falling edge is evaluated depending on the homing mode (parameter *Homing Mode* **1130**).

⁴⁾ A hardware limit switch is used for reversing the direction of rotation, depending on the homing mode (parameter *Homing Mode* **1130**). If the direction of rotation is reversed, value 0 is permissible (only in this case) and will not trigger an error.

⁵⁾ **Error messages:** Also refer to chapter "Positioning Error Messages"

F1445: Pos. and Neg. HW-Lim Switch Simultaneously

F1446: Limit Switch Incorrect Wired

F1447: Pos. HW Limit Switch

F1448: Neg. HW Limit Switch

⁶⁾ Dependent on *Operation Mode* **490**. Comply with the instructions in sections 3.4 and 3.5.1.4.

Assign S4IND and S5IND to the parameters for HW limit switches.

Values in parentheses (0) and (1) apply if the digital inputs for the limit switches are configured as inverted inputs (*brake contact function*), e.g. *Positive HW Limit Switch* **1138** = "540 - S4IND inverted (Hardware)".

In most homing operations, a home switch (cam) and a hardware limit switch will be required. Mind wiring and parameter configuration accordingly.

Input terminals for homing

Pos. HW Limit Switch 1138 =
"540 - S4IND inverted (Hardware)" → set
Neg. HW Limit Switch 1137 =
"541 - S5IND inverted (Hardware)" → set

Home Switch 1139 =
"75 - S6IND" (factory setting)

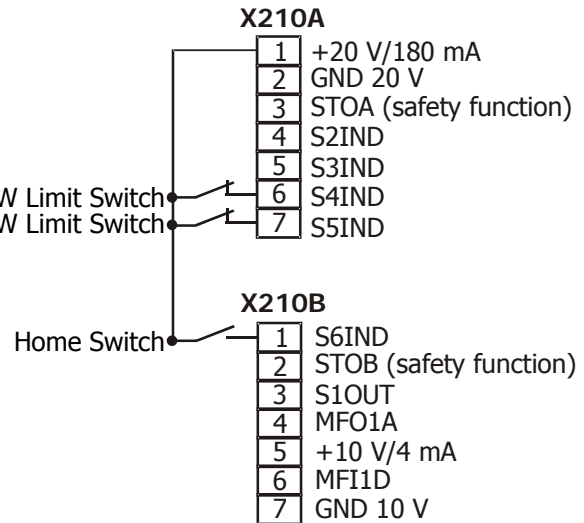

Manual start of homing

Operation Mode 1220 = "1 - manual" → set

Controller release:

Connect STOA (X210A.3) and STOB (X210B.2) for the safety function

Start Homing (manual) 1235 → Assign digital signal

Automatic start of homing

Operation Mode 1220 = "2 - automatic" (factory setting)

Controller release:

Connect STOA (X210A.3) and STOB (X210B.2) for the safety function

Start Positioning 1222 = S2IND (X210A.4)

For a description of the homing modes, refer to chapter 5 (List of homing modes).

Parameter		Settings		
No.	Description	Min.	Max.	Fact. sett.
1130	Homing Mode	0	35	0

Operation mode "59 – Homing Done" can be linked to a digital output or a logic signal.

Digital signal	Function
59 - Homing Done	Output signal if reference position is set (reference position defined). This is done by homing or by taking over the current position as the reference position.
159 - Inv. Homing Done	Like operation mode 59, but with inverted output signal.

Signal "614 – Homing Done" is available as an internal signal source for control functions.

Input and output signals for homing

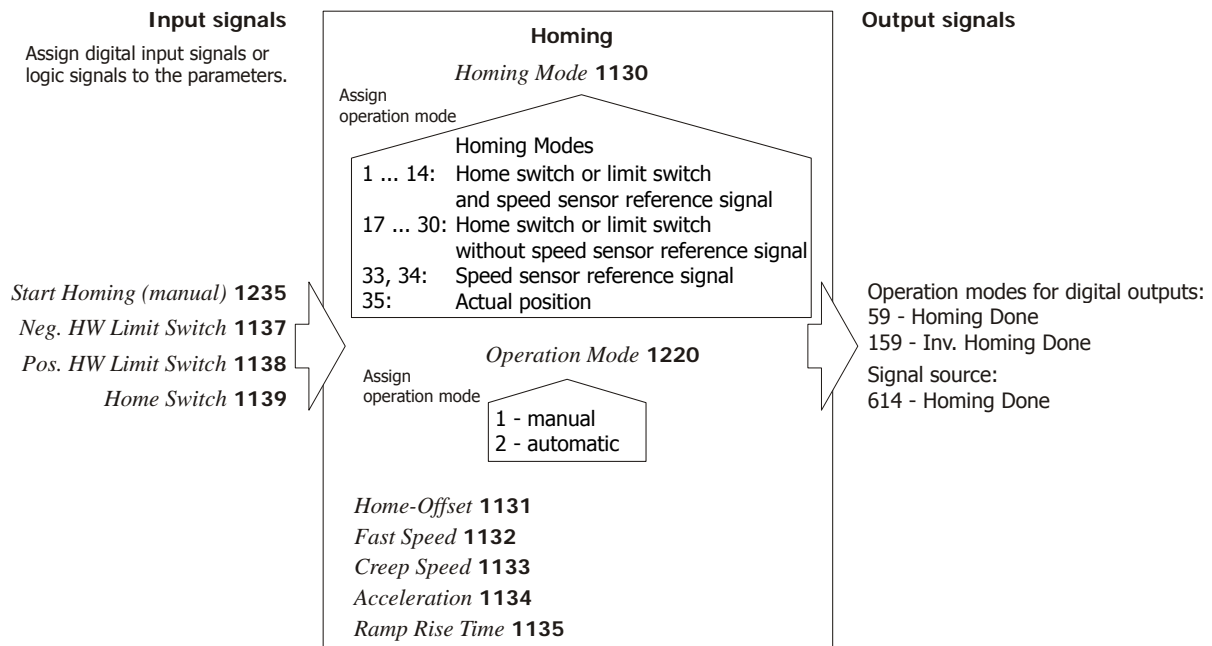

Attention! During manual homing, do not reset the homing control signal (parameter *Start Homing (manual)* **1235**). The control signal must be present until the "Homing Done" is signaled. Otherwise, homing is stopped. Without successful homing, no positioning operation can be started, i.e. error message "F1570 No Homing Done" will be displayed if you try to start a positioning operation.

4.2.3 Homing mode

Via parameter *Homing Mode* **1130**, you can define which signal will set the reference position, the direction in which the search for the point of reference is to be started, as well as the condition for reversing the direction for the reference position.

Possible signals for setting the reference position:

- Negative hardware limit switch (anticlockwise)
- Negative hardware limit switch (clockwise)
- Home switch
- Zero pulse of an encoder

For the homing mode suitable for the relevant application, refer to chapter "List of Homing Modes".

4.2.4 Home offset

With parameter *Home Offset* **1131**, the point of reference for positioning can be adjusted to the mechanical system.

The value adjusted for parameter *Home Offset* **1131** is added to the home position. Positive values will cause a shift of the point of reference in positive direction (clockwise), negative values will cause a shift in negative direction (anticlockwise).

Point of reference for positioning = home position + home offset

In the factory settings, the point of reference for positioning corresponds to the home position.

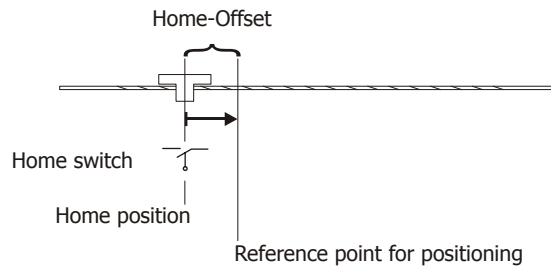

Parameter		Settings		
No.	Description	Min.	Max.	Fact. sett.
1131	Home-Offset	$-(2^{31}-1) \mu$	$2^{31}-1 \mu$	0 μ

4.2.5 Speed and acceleration of homing operation

Homing is started at fast speed. As soon as a certain point is reached, operation is continued at creep speed. The point at which the speed is changed depends on the homing mode selected.

The factory setting of parameter *Fast Speed* **1132** corresponds to a rotary frequency of 5 Hz for a four-pole machine with the reference system set to factory settings, *Creep Speed* **1133** corresponds to 1 Hz.

The direction is defined by the homing mode.

Parameter		Settings		
No.	Description	Min.	Max.	Fact. sett.
1132	Fast Speed	1 μ/s	$2^{31}-1 \mu/s$	163840 μ/s
1133	Creep Speed	1 μ/s	$2^{31}-1 \mu/s$	32768 μ/s

Via parameter *Acceleration 1134*, the acceleration and deceleration value to be used for homing is adjusted.

Parameter *Ramp Rise Time 1135* defines the time in which the frequency is to be brought to the acceleration and deceleration ramp adjusted for homing. In this way, a non-linear acceleration and deceleration (S-curve) can be obtained for homing, and the load during acceleration and deceleration of the drive can be reduced, e.g. in order to limit jerking. The factory setting of 0 ms causes a non-linear acceleration and deceleration ramp. The ramp rise time is added once per acceleration or deceleration operation.

Parameter		Settings		
No.	Description	Min.	Max.	Fact. sett.
1134	Acceleration	1 u/s ²	2 ³¹ -1 u/s ²	327680 u/s ²
1135	Ramp Rise Time	0 ms	2000 ms	0 ms

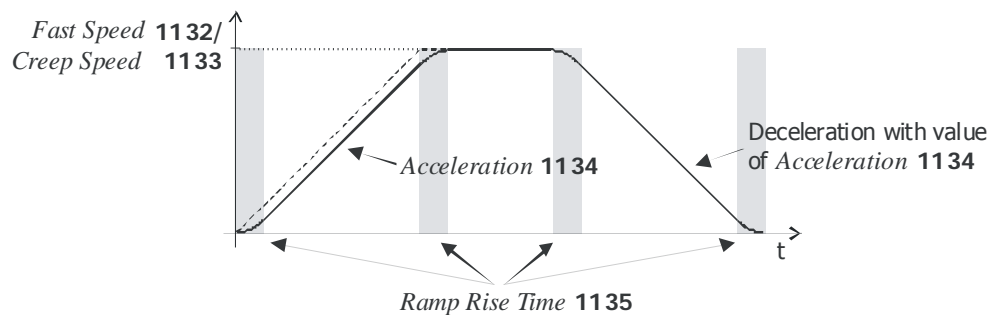

4.3 Positioning Mode

Positioning mode enables precise approaching of a target in a plant. By defining parameters such as speed, acceleration and ramp rise time, different application-specific load points can be considered. The different positioning modes and monitoring methods can be adjusted individually for each motion block. In this way, it is possible to mix absolute and relative positioning operations. The touch-probe evaluation additionally enables the definition of remaining distances via an initiator.

4.3.1 Motion block management

Different motion profiles can be configured in 32 motion blocks. A motion block contains parameter entries on:

- target position / distance
- speed
- acceleration
- deceleration
- Positioning mode (absolute, relative, touch-probe (sensor), speed (endless), combination with electronic gear)
- number of repetitions
- next motion block
- digital signal for logic links and communication interface

- Attention!**
- After changing motion profiles, you should test the automatic sequence of motion blocks at reduced speed. The scaled speed function can be activated via parameter *Speed Override* **1236**. For the test, an emergency stop device must be provided in order to be able to stop the drive immediately in the case of extraordinary movements.
 - If the load moment is changed while motion blocks are being processed, the target position may not be reached. The deceleration value set in the motion block is too low in this case in order to stop the axis at the target position.

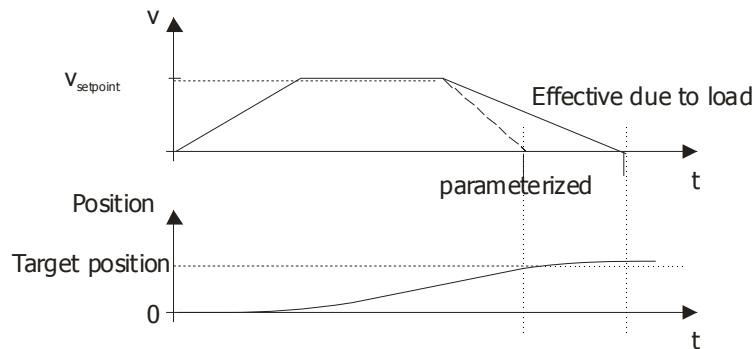

4.3.2 VTable

The control software VPlus enables access to the parameters of the frequency inverter. The additional program VTable which is included in VPlus enables easy and comfortable access to all 32 motion blocks at the same time. Motion blocks 1 to 32 are entered in VTable via index 1 to 32. Index 0 can be used in order to set a value in all motion blocks at the same time.

The parameters in the motion blocks perform one of three functions:

- [A] Target position incl. speed
- [B] Next motion block logic module
- [C] Setting of digital signal

The parameterized indices for *Mux Input* **1252** are independent from the motion block and can be used by the multiplexer for different digital signals [D].

Motion Blocks	Index 0	Index 1		
1202 Target Position / Distance	[A]	0 units		
1203 Speed		10000 u/s		
1204 Acceleration		100000 u/s ²		
1205 Ramp Rise Time		500 ms		
1206 Deceleration		100000 u/s ²		
1207 Ramp Fall Time		500 ms		
1208 Motion Mode		0 - absolute		
1209 Touch-Probe-Window		65536 units		
1210 Touch-Probe-Error: Next M...		-2		
1211 No. of Repetitions		0		
1212 Delay	[B]	0 ms		
1213 Delay: Next Motion Block		0		
1214 Event 1		75 - S6IND		
1215 Event 1: Next Motion Block		2		
1216 Event 2		7 - Off		
1217 Event 2: Next Motion Block		0		
1218 Digital Signal 1		12 - Start: off Ref.reached:		
1219 Digital Signal 2	[C]	0 - Start: --- Ref.reached: ---		
1247 Digital Signal 3		0 - Start: --- Ref.reached: ---		
1248 Digital Signal 4		0 - Start: --- Ref.reached: ---		
1260 Interrupt-Event 1		7 - Off		
1261 Int.-Event 1: Eval.-Mode	[B]	1 - Level-Controlled		
1262 Int.-Event 1: Next Motion Bl...		0		
1263 Interrupt-Event 2		7 - Off		
1264 Int.-Event 2: Eval.-Mode		1 - Level-Controlled		
1265 Int.-Event 2: Next Motion Bl...		0		
Mux/DeMux	[D]	Index 0	Index 1	Index 2
1252 Mux Input			7 - Off	7 - Off

4.4 Positioning Mode And Motion Block Data

4.4.1 Motion Mode

The positions are defined either in relation to a fixed reference position (absolute motion mode), in relation to other positions or a touch-probe sensor. Parameter *Motion Mode 1208* enables the selection.

Motion Mode 1208 = 0 - absolute

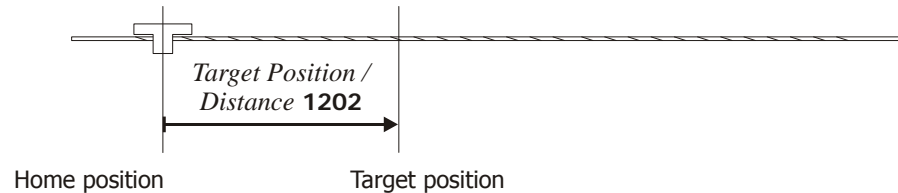

Motion Mode 1208 = 1 - relativ

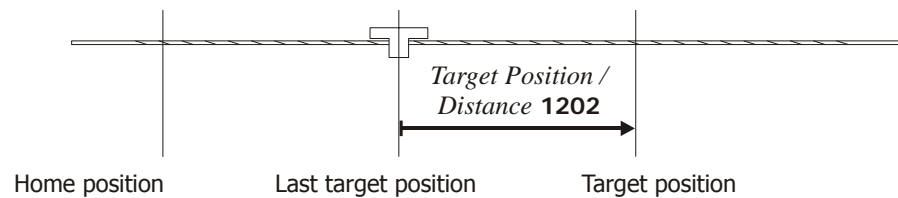

After JOG-Mode, *Motion Mode 1208 = 1 - relativ*

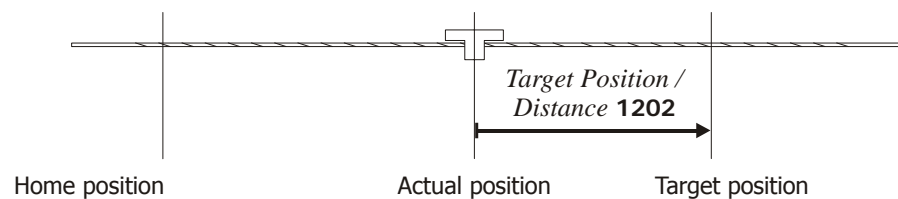

Motion Mode 1208 = 2 - Touch-Probe: Rising Edge
or
3 - Touch-Probe: Falling Edge

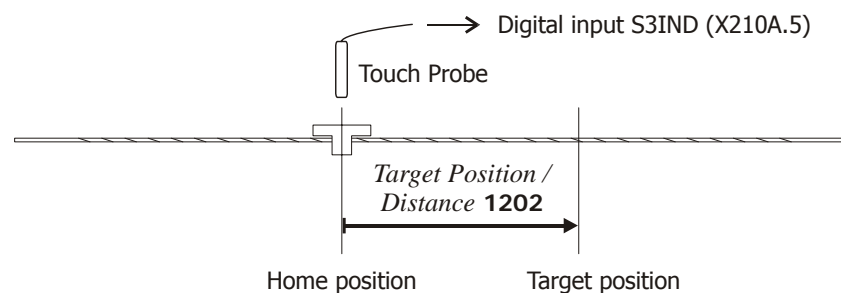

Motion Mode 1208 = "0 – absolute": An absolute position is a defined position on the motion path referred to the reference position. The absolute position is approached independent from the current position value.

Motion Mode 1208 = "1 – relative": A relative position refers to the previous target position or the current position after JOG mode.

Motion Mode 1208 = "2 – touch probe: rising edge" or "3 – touch probe: falling edge": a touch probe positioning operation refers to the reference position defined by a sensor signal.

The operation mode of parameter *Motion Mode 1208* defines the reference of the target position.

Operation modes 10 to 14 are combined with the function of an electronic gear.

<i>Motion Mode 1208</i>	Function
0 - absolute	Target position relates to the fixed reference position (point of reference for positioning). Factory setting. See chapter "4.4.1.1.
1 - relative	A relative positioning operation relates to a variable position. This may be the last target position or the current position reached in manual JOG mode. See chapter 4.4.1.2.
2 - Touch probe: rising edge	The rising edge of a digital signal on digital input S3IND is used for setting a reference point for a relative positioning operation. See chapter 4.4.1.3.
3 - Touch probe: falling edge	The falling edge of a digital signal on digital input S3IND is used for setting a reference point for a relative positioning operation. See chapter 4.4.1.3.
4 - Velocity	The drive moves at the speed profile parameterized in the selected motion block. The target position is not relevant and is not evaluated. See chapter 4.4.1.4
10 - Gearing, absolute	Absolute motion mode is combined with the electronic gearing function. The drive is synchronized with the master drive when it attains the master speed. See chapter 4.4.1.5.
11 - Gearing, relative	Relative motion mode is combined with the electronic gearing function. The drive is synchronized with the master drive when it attains the master speed. See chapter 4.4.1.5.
12 - Gearing, touch probe: rising edge	Operation mode 2 is combined with the electronic gearing function. The drive is synchronized with the master drive when it attains the master speed. See chapter 4.4.1.5.
13 - Gearing, touch probe: falling edge	Operation mode 3 is combined with the electronic gearing function. The drive is synchronized with the master drive when it attains the master speed. See chapter 4.4.1.5.
14 - Gearing	Like operation mode 4, but the drive moves at the speed profile defined by the electronic gear. The target position is not relevant and is not evaluated. The drive is synchronized with the master drive when it attains the master speed. See chapter 4.4.1.5.
20 - Gearing, direct sync., absolute	Absolute motion mode is combined with the electronic gearing function. The drive is accelerated to the master speed. At the start of a motion block the drive is synchronised with the master drive directly.
21 - Gearing, direct sync., relative	Relative motion mode is combined with the electronic gearing function. The drive is accelerated to the master speed. At the start of a motion block the drive is synchronised with the master drive directly.
22 - Gearing, direct sync., Touch-Probe: Rising Edge	Operation mode 2 is combined with the electronic gearing function. The drive is accelerated to the master speed. At the start of a motion block the drive is synchronised with the master drive directly.

<i>Motion Mode 1208</i>	Function
23 - Gearing, direct sync., Touch-Probe: Falling Edge	Operation mode 3 is combined with the electronic gearing function. The drive is accelerated to the master speed. At the start of a motion block the drive is synchronised with the master drive directly.
24 - Gearing, direct synchronisation	Like operation mode 4, but the drive moves at the speed profile defined by the electronic gear. The target position is not relevant and is not evaluated. The drive is accelerated to the master speed. At the start of a motion block the drive is synchronised with the master drive directly.

Note: If both a motor and a position encoder (two different encoders) are used, the function "Electronic Gear" cannot be used. Also refer to section "Two different encoders for motor and positioning", chapter 3.5.1.2.

The motion mode of the actual motion block can be displayed via parameter *Actual Motion Mode* **1255**.

4.4.1.1 Motion mode "absolute"

Parameter *Motion Mode* **1208** = "0 – absolute":

The target position is the position adjusted in the motion block at *Target Position/Distance* **1202**.

Target position relates to the fixed reference position (point of reference for positioning) which is determined by a homing operation. An absolute distance is covered, referred to the reference position.

When the target position is reached, logic signal "282 Target Position Reached" is set. The signal is reset when the next motion block is started or the drive leaves the target window (monitoring of current position at end of positioning).

In operation mode 60 or 160 (inverter), the logic signal "Target Position Reached" can be output via a digital output.

4.4.1.2 Motion mode "relative"

Parameter *Motion Mode* **1208** = "1 – relative":

A relative positioning operation relates to a position which was reached before. This may be the last target position or the current position reached in manual JOG mode.

If the last position was reached through a motion block positioning operation, *Target Position/Distance* **1202** indicates the value of a position in relation to the last target position, regardless of whether it was reached or not.

New target position = last target position + relative distance

If the last position was reached through a manual JOG operation, the value of parameter *Target Position/Distance* **1202** is a relative position relating to the current position.

New target position = current position + relative distance

4.4.1.3 Motion mode "touch probe" (sensor)

Activation of motion mode "touch probe":

- Parameter *Motion Mode* **1208** = "2 – touch probe: rising edge" or
- Parameter *Motion Mode* **1208** = "3 – touch probe: falling edge"

The rising or falling edge of a digital signal on digital input S3IND (terminal 210A.5) is used for setting a reference point for a relative positioning operation. As soon as the signal is received, the drive moves by the relative distance of parameter *Target Position/Distance* **1202**. The function is permanently linked to digital input S3IND, parameterization on another digital input is not possible. The touch probe signal must be connected to this input when a touch probe motion mode is selected.

The function can be used in order to position the front edge of workpieces of a different length at the same place, for example. A momentary contact switch can supply the touch-probe signal.

The current position is set as the reference position when the rising edge (operation mode 2) or the falling edge (operation mode) is received on the digital input (touch probe signal).

The touch probe position is the position at which a rising/falling edge is received on digital input S3IND plus the value of parameter *Target Position/Distance* **1202**.

Note: By default, digital input S3IND is assigned the function "Stop Positioning". Change the occupation of parameter *Stop Positioning* **1223** and, if necessary, change wiring if touch probe function is used.

Motion Mode 1208 = 2 - Touch-Probe: Rising Edge
or
3 - Touch-Probe: Falling Edge

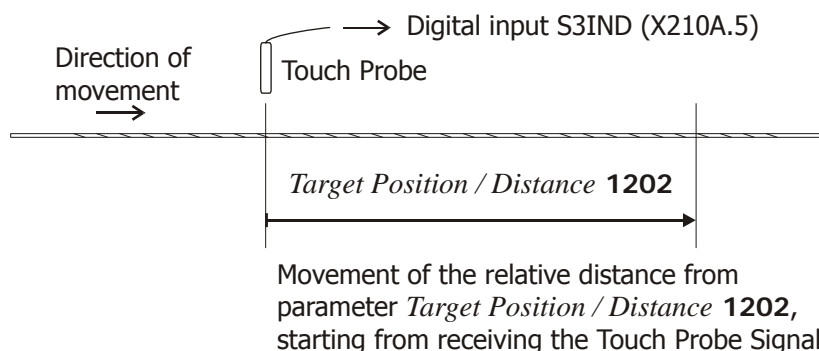

If the value of parameter *Target Position/Distance* **1202** is too low in order to stop at the target position at the deceleration entered in the motion block, the target position is passed, the direction is reversed and the position is approached from the opposite side.

In parameter *Touch-Probe-Window* **1209**, you can enter the range in which the touch probe signal must be received. The starting point of the touch probe window is the last target position or the current position in JOG mode.

The end point of the touch probe window is in the direction of the motion.

If 0 is entered in parameter *Touch-Probe-Window* **1209**, the touch probe window is deactivated.

Parameter		Setting		
No.	Description	Min.	Max.	Fact. sett.
1209	Touch-Probe-Window	0 u	$2^{31}-1$ u	65 536

If no touch-probe signal is received within the touch probe window, the settings of parameter *Touch-Probe-Error: Next Motion Block 1210* will become effective.

<i>Touch-Probe-Error: Next Motion Block 1210</i>	Function
-3 - Em. stop, error (Minus 3)	The drive is stopped via <i>Emergency Ramp 1179</i> , after that, error message "F1573 No touch probe signal detected" is output.
-2 - Stop, error (Minus 2)	Factory setting. The drive is stopped at the active deceleration ramp from parameters <i>Deceleration 1206</i> and <i>Ramp Fall Time 1207</i> , after that, error message "F1573 No touch probe signal detected" is output.
-1 - Error Switch-Off (Minus 1)	The drive is stopped, after that, error message "F1573 No touch probe signal detected" is output. Coast-down of the drive.
0 - deactivated	Positioning operation and processing of next motion blocks is stopped.
1 ... 32	The corresponding motion block is executed.

Example: Motion mode touch probe

Example: Touch probe	
<i>Target Position / Distance 1202</i>	14250 u
<i>Motion Mode 1208</i>	2 – touch probe: rising edge
<i>Touch-Probe-Window 1209</i>	10000 u
<i>Touch-Probe-Error: Next Motion Block 1210</i>	-3

Touch probe signal: set reference point and move

1. Touch Probe signal is received within the Touch-Probe-Window. The actual position is saved as home position.
2. Movement of the relative distance from parameter *Target Position / Distance 1202*
3. Stop at the target position with the value of parameter *Deceleration 1206*

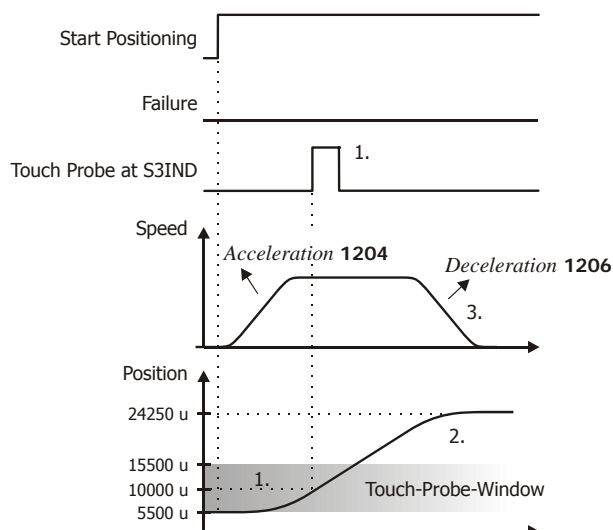

No signal within touch probe signal

1. No Touch Probe signal is received within the Touch-Probe-Window.
2. Shutdown of the drive with *Touch-Probe-Error: Next Motion Block 1210* = "-3 - Em. stop, error" (*Emergency Ramp 1179*)
3. Failure message "F1573 No Touch Probe Signal Detected".

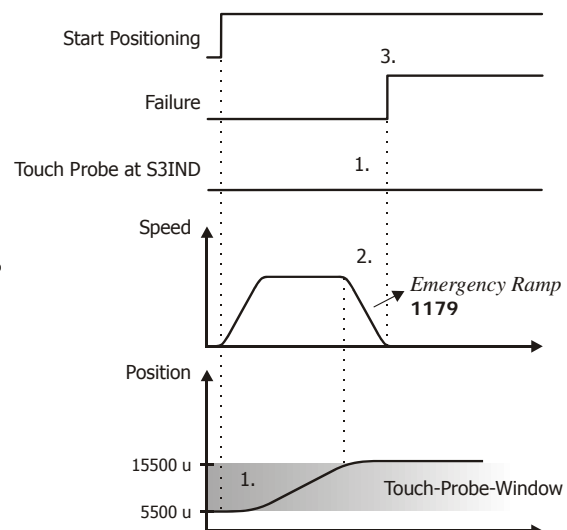

4.4.1.4 Motion mode "velocity"

Parameter *Motion Mode* **1208** = "4 – velocity":

The drive is accelerated to *Speed* **1203** at the motion profile set in the motion block. Settings for *Target Position / Distance* **1202** will not be evaluated. The motion block remains active until another motion block is selected. Jumping to motion blocks with other motion modes, e.g. "absolute" or "relative" is possible.

Motion block selection

The motion blocks can be selected via:

- *Delay* **1212**
- *Delay: Next motion block* **1213**
- *Event 1* **1214**
- *Event 1: Next Motion Block* **1215**
- *Event 2* **1216**
- *Event 2: Next Motion Block* **1217**
- *Interrupt-Event 1* **1260**
- *Int.-Event 1: Next Motion Block* **1262**
- *Interrupt-Event 2* **1263**
- *Int.-Event 2: Next Motion Block* **1265**

Example: Motion block sequence in motion mode "velocity"

Motion blocks	Index 3	Index 4	Index 5
<i>Motion Mode</i> 1208	4 - velocity	4 - velocity	4 - velocity

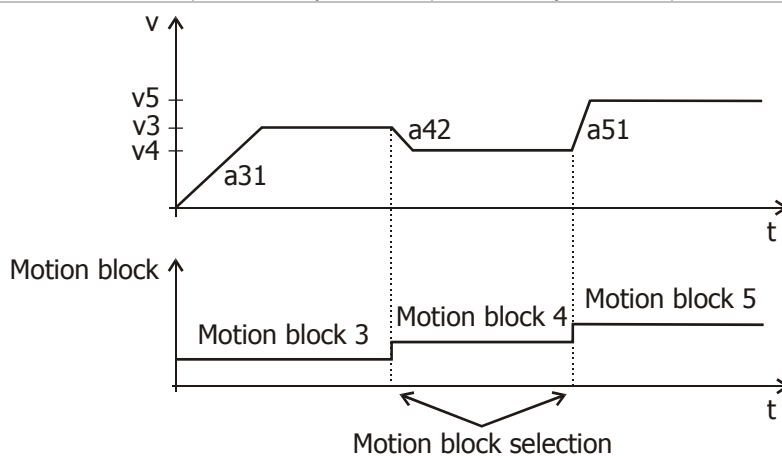

v3: *Speed* **1203** from motion block 3,
a31: *Acceleration* **1204** from motion block 3

v4: *Speed* **1203** from motion block 4,
a42: *Delay* **1205** from motion block 4

v5: *Speed* **1203** from motion block 5,
a51: *Acceleration* **1204** from motion block 5

If the value of *Speed* **1203** is reached, this can be signalized. For one of the parameters *Digital Signal 1* **1218**, *Digital Signal 2* **1119**, *Digital Signal 3* **1247** or *Digital Signal 4* **1248** an operation mode with „Ref.reached: on” must be selected. See chapter 4.4.6.

4.4.1.5 Combination with electronic gear

Positioning operation modes 10 to 14 and 20 to 24 (parameter *Motion Mode 1208*) are combined with the electronic gearing function.

Operation modes 10 to 14, "Gearing"	Operation modes 20 to 24, "Gearing, direct synchronisation"
Synchronisation at attaining the master speed	Direct synchronization at the start of a motion block

Operation modes 10 to 14, "Gearing"

The drive accelerates the master speed at the ramps parameterized in the motion block. As soon as the master speed is reached for the first time, the drive is synchronized with the master drive. The slave is engaged at the current position and operates at a synchronous angle with the master. In the case of a relative positioning operation, this engaging position is used as the start position.

The acceleration and deceleration for synchronization occurs according to the characteristic of an S-shaped curve.

Logic signal "57 – In Gear" signals synchronous operation and can be output via a digital output. Logic signal "624 – In Gear" can be used for logic functions.

During synchronous operation, the ramps parameterized in the motion block are deactivated. Acceleration and deceleration are defined by the master.

The slave unit calculates the delayed starting point internally from the parameterized target position and the corresponding delay. As soon as this point is reached, the unit disengages from the master and starts the deceleration. Logic signals "57 – In Gear" and "624 – In Gear" are reset.

The drive speed is limited by the value adjusted for parameter *Maximum Frequency 419*, even if the master drive exceeds this value. Logic signals "57 – In Gear" and "624 – In Gear" are reset in this case.

Operation modes 20 to 24, "Gearing, direct synchronisation"

The drive accelerates the master speed at the ramps parameterized in the motion block. At the start of a motion block the drive is synchronized with the master drive directly. The master speed is processed by the position controller directly.

The acceleration and deceleration for synchronization occurs according to the characteristic of an S-shaped curve.

Logic signal "57 – In Gear" signals synchronous operation and can be output via a digital output. Logic signal "624 – In Gear" can be used for logic functions.

During synchronous operation, the ramps parameterized in the motion block are deactivated. Acceleration and deceleration are defined by the master.

The drive speed is limited by the value adjusted for parameter *Maximum Frequency 419*, even if the master drive exceeds this value. Logic signals "57 – In Gear" and "624 – In Gear" are reset in this case.

For jerk reduction the output of the position controller can be limited via Parameter *Limitation 1118*. The value limits the speed for compensation of the position deviation during synchronisation. Refer to chapter 4.12 "Position Controller".

Note: If both a motor and a position encoder (two different encoders) are used, the function "Electronic Gear" can only be used via system bus.

Direction of movement at the start of the positioning

Motion mode

Gearing, absolute or relative

The initial direction is dependent on the target position
Target position is in direction

Positive:

Slave-drive is accelerated to the master speed in the same direction

Negative:

Slave-drive is accelerated to the master speed in the opposite direction

Gearing, Touch-Probe

Slave-drive is accelerated to the master speed in the same direction

Gearing

Slave-drive is accelerated to the master speed in the same direction. The operational behavior corresponds to the electronic gear function in the configurations x15. Refer to the application manual "Electronic Gear".

After drives are in synchronous operation, a reversal of the master-drive results in a reversal of the slave-drive independent of the motion mode.

Signals for synchronization acknowledgement

The synchronous operation of the drive and master drive is indicated by the signal "In Gear".

- Logic signal "57 - In Gear" can be output via a digital output.
- Logic signal "624 - In Gear" can be used for logic functions.

The signals "In Gear" are set if the relative deviation between master- and slave-position is lower than the value of "*In-Gear*"-Threshold **1168** for at least „*In-Gear*"-Time **1169**.

Parameter		Setting		
No.	Description	Min.	Max.	Fact. sett.
1168	"In-Gear"-Threshold	1 u	$2^{31}-1$ u	0 u
1169	"In-Gear"-Time	1 ms	65535 ms	10 ms

Note: If parameter "*In-Gear*"-Threshold **1168** is set to the value zero the signals "In Gear" are set when the drive attains the master speed.

The signals "In Gear" are reset in the following occurrences:

- The relative deviation between master- and slave-position exceeds the value of "*In-Gear*"-Threshold **1168**.
- The drive is decelerated according to the ramps defined in the motion block and stops at the target position.
- The speed of the master drive exceeds the value of *Maximim Frequency* **419** *.

* The speed of the slave-drive is limited to *Maximim Frequency* **419**.

Motion mode "Gearing", synchronisation at master speed

Activation of motion mode "Gearing":

- Parameter *Motion Mode 1208* = "10 - Gearing, absolute" or
- Parameter *Motion Mode 1208* = "11 - Gearing, relative" or
- Parameter *Motion Mode 1208* = "14 - Gearing"

1. Acceleration with ramps from the motion block (*Acceleration 1204*)
 2. Synchronisation of drive and master after attaining the master speed.
 3. Synchronisation message via logic signal "In Gear"
 4. Movement to the target position with the deceleration value from the motion block (*Deceleration 1206*).
- Reset of logic signal "In Gear".

The position P_{dec} where the deceleration begins is calculated from target position, speed and deceleration ramp. When P_{dec} is reached the slave is uncoupled from the master and moves to the target position.

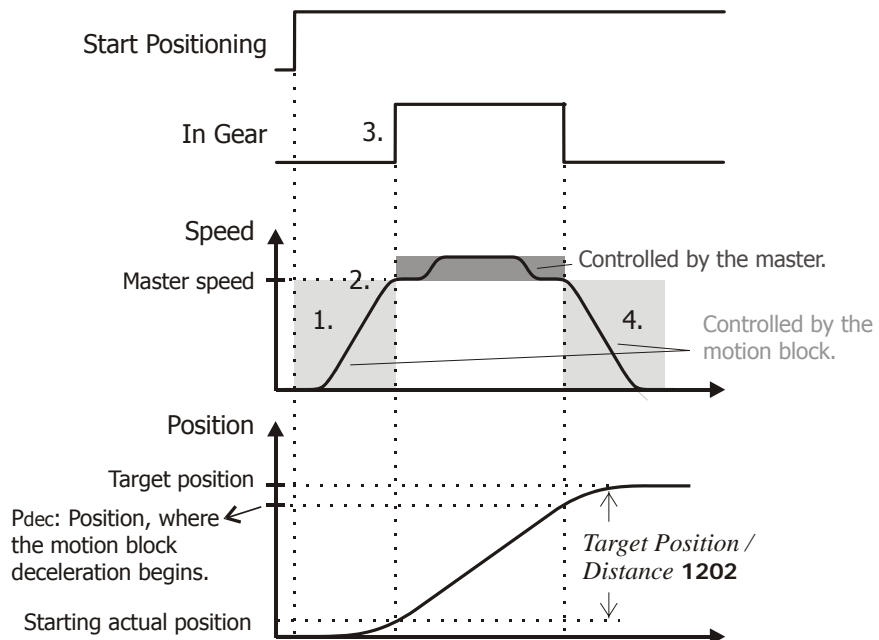

Motion mode "Gearing, touch probe", synchronisation at master speed

Activation of motion mode "Gearing, touch probe":

- Parameter *Motion Mode 1208* = "12 - Gearing, touch probe: rising edge" or
- Parameter *Motion Mode 1208* = "13 - Gearing, touch probe: falling edge"

Motion mode 12 corresponds to motion mode 2 - "Touch probe: rising edge", but contains the additional electronic gearing function. For motion mode 2 refer to chapter 4.4.1.3.

Motion mode 13 corresponds to motion mode 3 - "Touch probe: falling edge", but contains the additional electronic gearing function. For motion mode 2 refer to chapter 4.4.1.3.

1. Acceleration with ramps from the motion block (*Acceleration 1204*, *Ramp Rise Time 1205*).
2. Synchronisation of drive and master after attaining the master speed.
3. Synchronisation message via signals 57- and 624- "In Gear".
4. Movement of the relative distance *Target Position/Distance 1202* (after receiving the touch probe signal).
5. Stopping with *Deceleration 1206* and *Ramp Fall Time 1207* from motion block.

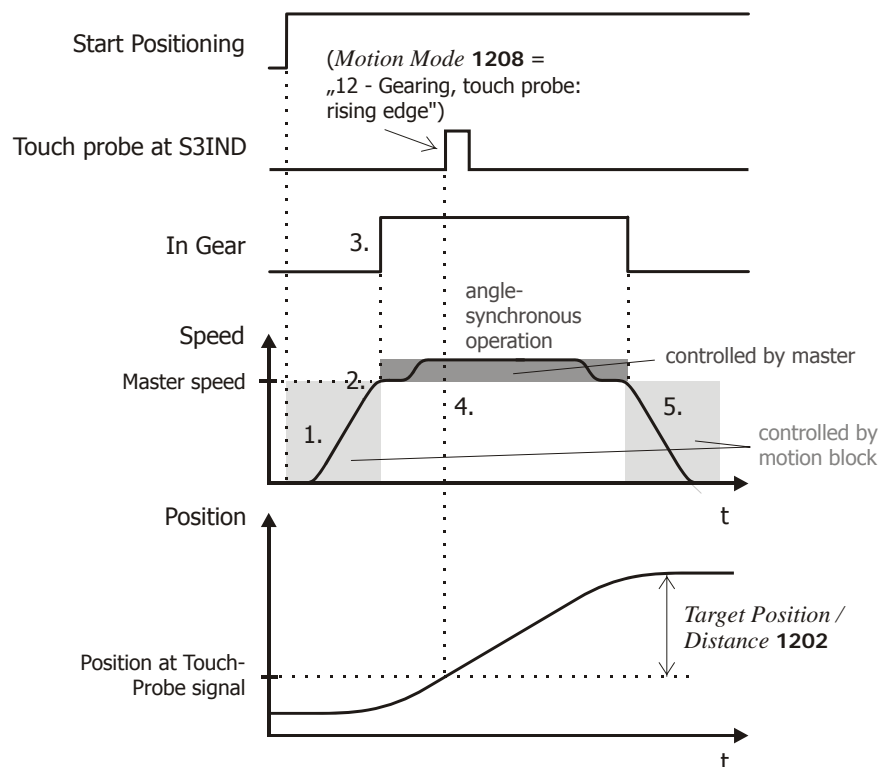

Positioning mode "Gearing, direct synchronisation"

Activation of motion mode "Gearing, direct synchronisation"

- Parameter *Motion Mode 1208* = "20 - Gearing, direct sync., absolute" or
- Parameter *Motion Mode 1208* = "21 - Gearing, direct sync., relative" or
- Parameter *Motion Mode 1208* = "24 - Gearing direct synchronisation"

With Touch-Probe signal:

- Parameter *Motion Mode 1208* = "22 - Gearing, direct sync., Touch-Probe, pos. Edge" or
- Parameter *Motion Mode 1208* = "23 - Gearing, direct sync., Touch-Probe, neg. edge"

Gearing, direct synchronisation

1. Synchronisation of slave position and position of master drive
2. Acceleration with ramps from the motion block (*Acceleration 1204*)
3. Synchronisation message via logic signal "In Gear"

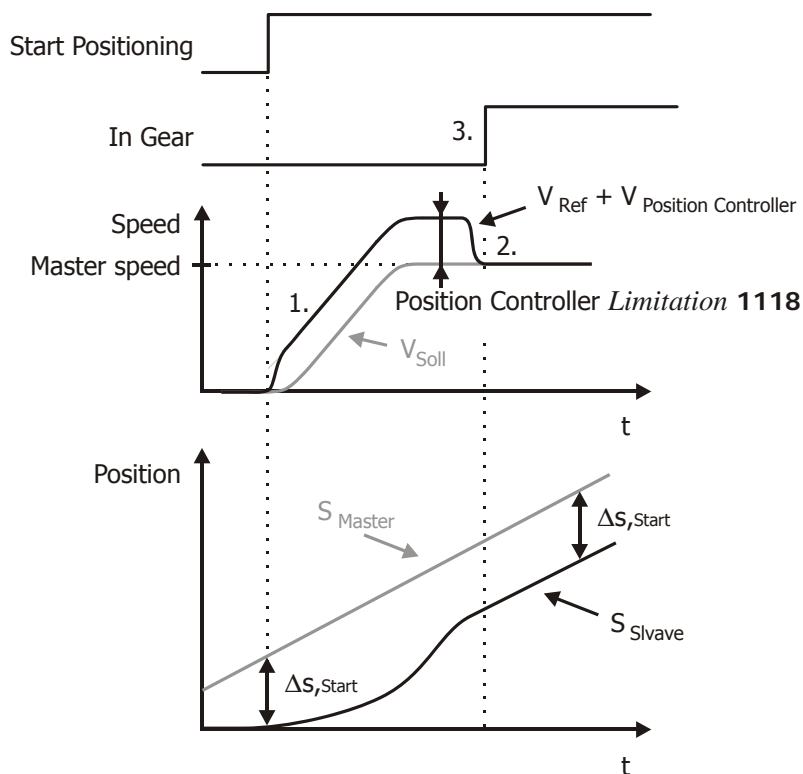

Attention! During the processing of motion blocks and operation modes with electronic gearing for *Motion Mode 1208*, the direction of motion of the axis may be reversed. The speed defined by the master is too high in order to reach the target position at the deceleration set in the motion block. In this case, the target position is passed with the current deceleration and then approached from the opposite direction.

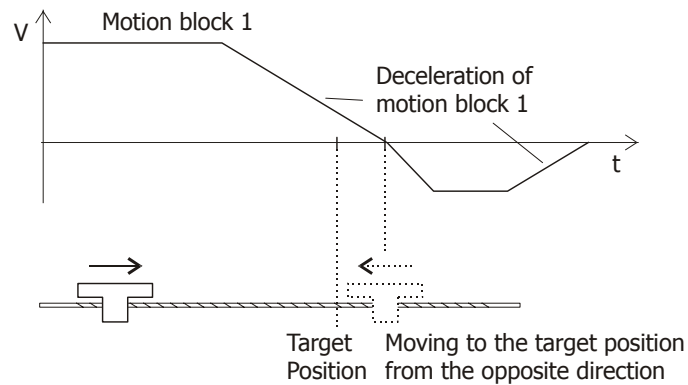

Attention! In motion operation modes with electronic gearing the speed override function is deactivated.

Parameter *Master Speed 1129* indicates the speed of the master on the output of the electronic gear in the operation modes with electronic gear (*Motion Mode 1208*).

Note: For more information on the function of the electronic gear, refer to the chapter "Electronic Gear" and the application manual "Electronic Gear".

4.4.2 Motion block data

The data of each motion block is saved separately. The motion block data consist of values for:

Target	Logic	Digital signal
Position Speed Acceleration Deceleration Ramp rise times	Next motion block - Event - Interruption Event - Delay	Digital signals for indication of status of motion orders

4.4.2.1 Target position

Parameter *Target Position/Distance* **1202** defines the distance to be covered.

The meaning of the parameter depends on parameter *Motion Mode* **1208**.

In *Motion Mode* **1208** = "0 – absolute", an absolute target position is approached, referred to the reference position.

In *Motion Mode* **1208** = "1 – relative", a distance in relation to the current position or the last target position is covered.

If the last position was reached via the JOG function, the value of the parameter is a relative position relating to the current position (distance). However, if the last position was selected as a result of a motion command, the value indicates a position in relation to the last target position (distance).

Parameter		Setting		
No.	Description	Min.	Max.	Fact. sett.
1202	Target Position / Distance	-2^{31} u	$2^{31}-1$ u	65536 u

Note: The target position / distance must be within the range of the software limit switches in order to be able to start a motion order.

4.4.2.2 Speed

The target position is approached at the value of parameter *Speed* **1203**. The distance to the target position and the parameterized acceleration and deceleration determine if the speed is reached.

Parameter		Setting		
No.	Description	Min.	Max.	Fact. sett.
1203	Speed	$-(2^{31}-1)$ u/s	$2^{31}-1$ u/s	163840 u/s

Note: In the operation modes with electronic gear (Parameter *Motion Mode* **1208**), the settings for parameter *Speed* **1203** do not have any effect. The speed is defined by the master.

Parameter *Act. Speed* **1107** indicates the current speed in unit [u/s].

4.4.2.3 Acceleration and Deceleration

For parameters *Acceleration 1204* and *Deceleration 1205*, the values for the motion to the target position are adjusted.

Via the ramp rise time, a non-linear acceleration and deceleration (S-curve) can be obtained, and the load during acceleration and deceleration of the drive can be reduced, e.g. in order to limit jerking. The factory setting of 0 ms causes a linear ramp.

Parameter		Setting		
No.	Description	Min.	Max.	Fact. sett.
1204	Acceleration	1 u/s ²	2 ³¹ -1 u/s ²	327 680 u/s ²
1205	Ramp Rise Time	0 ms	2000 ms	0 ms
1206	Deceleration	1 u/s ²	2 ³¹ -1 u/s ²	327 680 u/s ²
1207	Ramp Fall Time	0 ms	2000 ms	0 ms

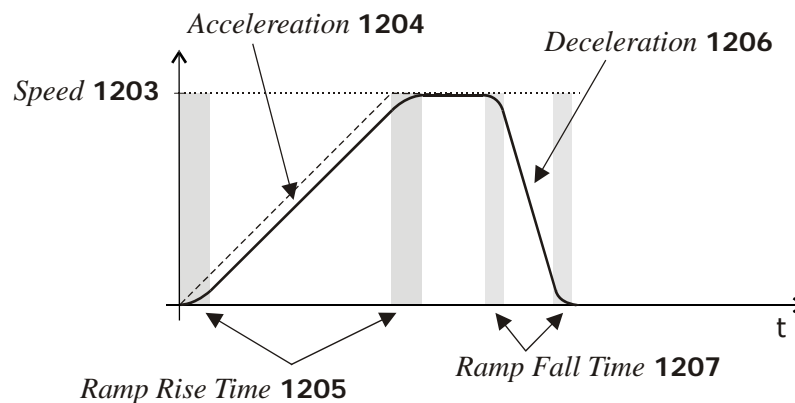

4.4.2.4 Automatic sequence of motion blocks (next motion block)

In parameter configuration *Operation Mode 1221* = 1xx (e.g. 101, 111, "Sequence Mode"), the positioning function enables an automatic sequence of motion blocks, i.e. when the target position is reached, the next target position is selected. The sequence control can be time-based (e.g. after a certain time has elapsed) or event-oriented (e.g. via digital inputs or logic modules).

The next motion block starts:

- After expiry of a delay time:
After expiry of *Delay 1212* the motion block from *Delay: Next Motion Block 1213* starts.
- After attaining a target position:
Event 1 1214 starts the motion block from *Event 1: Next Motion Block 1215*.
Event 2 1216 starts the motion block from *Event 2: Next Motion Block 1217*.
- After interruption of a running motion block:
Interrupt-Event 1 1260 starts the motion block from *Int.-Event 1: Next Motion Block 1262*.
Interrupt-Event 2 1263 starts the motion block from *Int.-Event 2: Next Motion Block 1265*.

In that way logic-specific branches in the sequences can be parameterized.

In the case of a relative positioning operation, the motion block can also be repeated via *No. of Repetitions 1211*.

Motion blocks are processed automatically in the following order:

- Motion block is selected
- Motion block is executed with or without repetition
- Interrupt a motion block and jump to the next motion block under configurable conditions according to priority
 - a) *Int.-Event 1: Next Motion Block 1262*
 - b) *Int.-Event 2: Next Motion Block 1265*
- Jump to next motion block under configurable conditions according to priority:
 - a) *Event 1: Next Motion Block 1215*
 - b) *Event 2: Next Motion Block 1217*
 - c) *Delay: Next Motion block 1213*

Valid next motion blocks are individual motion blocks 1 to 32. Value 0 (factory setting) stops the positioning operation. If *Operation Mode 1221* = 11x ("with restart") is selected, the sequence will be restarted as described above. If *Operation Mode 1221* = 10x ("without restart") is selected, the positioning operation will not start before the next positive edge of the signal assigned to parameter *Start Positioning 1222* is received.

Input and output signals for automatic motion block sequence

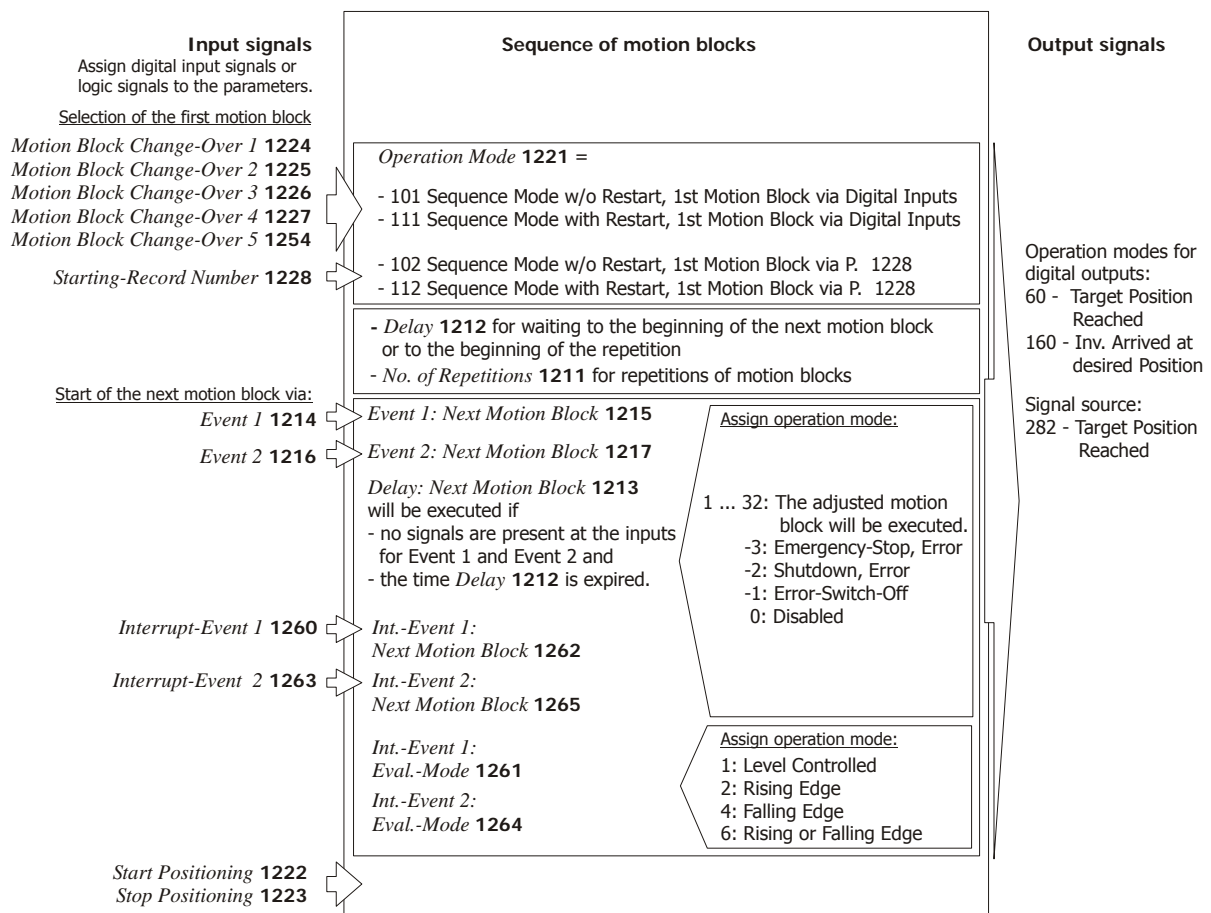

Automatic sequence

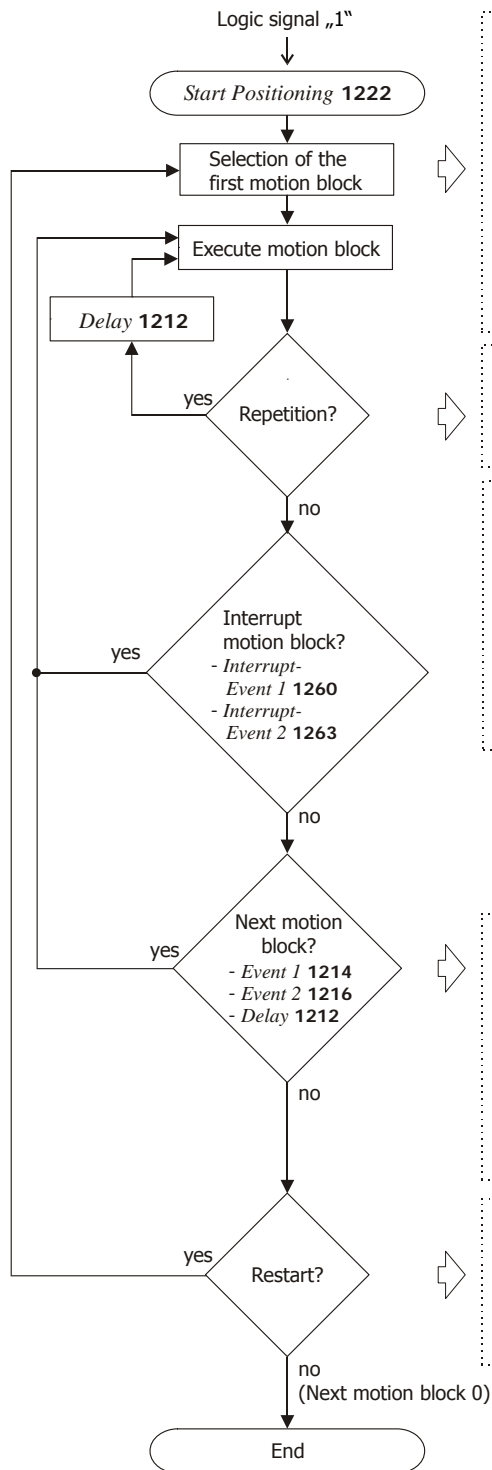

First motion block via digital inputs:

In the settings of
Operation Mode 1221:
 101 - Sequence Mode w/o Restart,
 1st Motion Block via Digital Inputs
 111 - Sequence Mode with Restart,
 1st Motion Block via Digital Inputs

Adjustment of parameters
Motion Block Change-Over 1 1224
Motion Block Change-Over 2 1225
Motion Block Change-Over 3 1226
Motion Block Change-Over 4 1227

First motion block via parameter:

In the settings of
Operation Mode 1221:
 102 - Sequence Mode w/o Restart,
 1st Motion Block via P. 1228
 112 - Sequence Mode with Restart,
 1st Motion Block via P. 1228

Adjustment of parameter
Starting-Record Number 1228

Repetitions:

Adjustment of parameter
No. of Repetitions 1211

Repetitions are possible for the settings
 of parameter **Motion Mode 1208:**
 1 - relativ
 2 - Touch-Probe: Rising Edge
 3 - Touch-Probe: Falling Edge

Interrupt motion block & start next motion block:

Interrupt-Event 1 1260	Interrupt-Event 2 1263	Next motion block from parameter
1	1	Int.-Event 1: Next Motion Block 1262
1	0	Int.-Event 1: Next Motion Block 1262
0	1	Int.-Event 2: Next Motion Block 1265

Possible settings of the parameters:
 1 ... 32: The adjusted parameter will be executed.
 -3: Emergency-Stop, Error
 -2: Shutdown, Error
 -1: Error-Switch-Off
 0: Disabled

Next motion block:

Event 1 1214	Event 2 1216	Delay 1212	Next motion block from parameter
1	1	≥ 0	Event 1: Next Motion Block 1215
1	0	≥ 0	Event 1: Next Motion Block 1215
0	1	≥ 0	Event 2: Next Motion Block 1217
0	0	> 0	Delay: Next Motion Block 1213
0	0	0	Next Motion Block 0 Restart?

Restart; begin with the first motion block:

Setting of **Operation Mode 1221**
 111 - Sequence Mode with Restart,
 1st Motion Block via Digital Inputs
 112 - Sequence Mode with Restart,
 1st Motion Block via P. 1228

Note: Repetitions are executed for relative or touch-probe motions only. Absolute motions have a fixed target position.

After **completion** of the current motion order, a new motion order can be started automatically.

As soon as the positioning operation is started with the corresponding logic signal for parameter *Start Positioning* **1222**, the operation is started with the first motion block.

When the target position is reached the settings are evaluated for parameters:

- *Delay* **1212**
- *Delay: Next motion block* **1213**
- *Event 1* **1214**
- *Event 1: Next Motion Block* **1215**
- *Event 2* **1216**
- *Event 2: Next Motion Block* **1217**

If parameter *Event 1* **1214** receives a logic signal via the assigned input, the motion block adjusted in parameter *Event 1: Next Motion Block* **1215** is activated.

If a signal is present on *Event 2* **1216**, *Event 2: Next Motion Block* **1217** will be activated.

If logic signals are present on Event 1 and Event 2 at the same time, the motion block from parameter *Event 1: Next Motion Block* **1215** will be activated.

In parameter *Delay* **1212**, you can set the time which is to pass before the next motion block is processed. In this time, Event 1 and Event 2 will be evaluated. The delay time will not elapse completely if Event 1 or Event 2 occurs in this time. If there are no logic signals on Event 1 nor on Event 2 after the delay has elapsed, the motion block set in parameter *Delay: Next Motion Block* **1213** will be processed. The setting *Delay* **1212** = 0 deactivates the function *Delay: Next Motion Block* **1213**.

If motion block *No. of Repetitions* **1211** is set, this motion block is repeated. Repetitions are executed for relative or touch-probe motions only. The repetition will not be started before the time set in parameter *Delay* **1212** has elapsed.

<i>Motion Mode</i> 1208	Function
0 – absolute	<i>No. of Repetitions</i> 1211 is not evaluated.
1 – relative	Settings of parameter <i>No. of Repetitions</i> 1211 are evaluated.
2 – touch probe: rising edge	
3 – touch probe: falling edge	

Parameter		Setting		
No.	Description	Min.	Max.	Fact. sett.
1211	No. of Repetitions	0	255	0
1212	Delay	0 ms (=deactivated)	65 535 ms	0 ms (=deactivated)
1213	Delay: Next Motion Block	-3	32	0

Note: If repetitions (parameter *No. of Repetitions* **1211**) are set, the delay (parameter *Delay* **1212**) will be evaluated during the repetitions only. The settings for Event 1 and Event 2 will become active only after the last repetition and the delay.

After **interruption** of the current motion order, a new motion order can be started automatically.

During a running motion block the settings are evaluated for parameters:

- *Interrupt-Event 1* **1260**
- *Int.-Event 1: Next Motion Block* **1262**
- *Interrupt-Event 2* **1263**
- *Int.-Event 2: Next Motion Block* **1265**

If parameter *Interrupt-Event 1* **1260** receives a logic signal via the assigned input, the motion block adjusted in parameter *Int.-Event 1: Next Motion Block* **1262** is activated.

If a signal is present on *Interrupt-Event 2* **1263**, *Int.-Event 2: Next Motion Block* **1265** will be activated.

Priority:

If logic signals for interruption are present on Event 1 and Event 2 at the same time, the motion block from parameter *Int.-Event 1: Next Motion Block* **1262** will be activated.

Interruption, level controlled or edge-triggered

The signals for *Interrupt-Event 1* **1260** and *Interrupt-Event 2* **1263** can be evaluated level controlled or edge-triggered. The evaluation can be set via the parameters *Int.-Event 1: Eval.-Mode* **1261** and *Int.-Event 2: Eval.-Mode* **1264**.

Operation modes for parameters 1261 and 1264	Function
1 - Level Controlled	<ul style="list-style-type: none"> – If parameter 1261 is set to this mode: The level of the signal (which is assigned to parameter 1260) interrupts the running motion block and starts the next motion block from parameter 1262. – If parameter 1264 is set to this mode: The level of the signal (which is assigned to parameter 1263) interrupts the running motion block and starts the next motion block from parameter 1265.
2 - Rising Edge	The same as operation mode 1, but a rising edge interrupts the running motion block and starts the next motion block.
4 - Falling Edge	The same as operation mode 1, but a falling edge interrupts the running motion block and starts the next motion block.
6 - Rising or Falling Edge	The same as operation mode 1, but a rising edge or falling edge interrupts the running motion block and starts the next motion block.

Set the next motion block, stop of the drive or error switch-off for an event:

By entering one of the listed values for parameters

- *Delay: Next Motion Block* **1213**
- *Event 1: Next Motion Block* **1215**
- *Event 2: Next Motion Block* **1217**
- *Int.-Event 1: Next Motion Block* **1262**
- *Int.-Event 2: Next Motion Block* **1265**

the next motion block or user-defined behavior in the case of events can be selected. Errors in the motion sequence can be identified quickly by emergency stop, stop and the error switch-off function.

<i>Next motion block</i> 1213, 1215, 1217, 1262, 1265	Function
-3 - (Minus 3) Em. stop, error	The drive is stopped via <i>Emergency Ramp 1179</i> , after that, error message "F15XX User-Defined Error in Motion Block" is output.
-2 - (Minus 2) Stop, error	The drive is stopped at the active deceleration ramp, after that, error message "F15XX User-Defined Error in Motion Block" is output.
-1 - (Minus 1) Error Switch-Off	The drive is switched off, after that, error message "F15XX User-Defined Error in Motion Block" is output.
0 - Disabled	Factory setting. Processing of next motion blocks is switched off.
1 ... 32	The corresponding motion block is executed.

Parameter		Setting		
No.	Description	Min.	Max.	Fact. sett.
1214	Event 1	Logic signal or digital input		7 - Off
1215	Event 1: Next Motion Block	-3	32	0 - Disabled
1216	Event 2	Logic signal or digital input		7 - Off
1217	Event 2: Next Motion Block	-3	32	0 - Disabled
1260	Interrupt-Event 1	Logic signal or digital input		7 - Off
1261	Int.-Event 1: Eval.-Mode	1	6	1 - Level Controlled
1262	Int.-Event 1: Next Motion Block	-3	32	0 - Disabled
1263	Interrupt-Event 2	Logic signal or digital input		7 - Off
1264	Int.-Event 2: Eval.-Mode	1	6	1 - Level Controlled
1265	Int.-Event 2: Next Motion Block	-3	32	0 - Disabled

Example: Start of the next motion block after delay expiry and by event 1

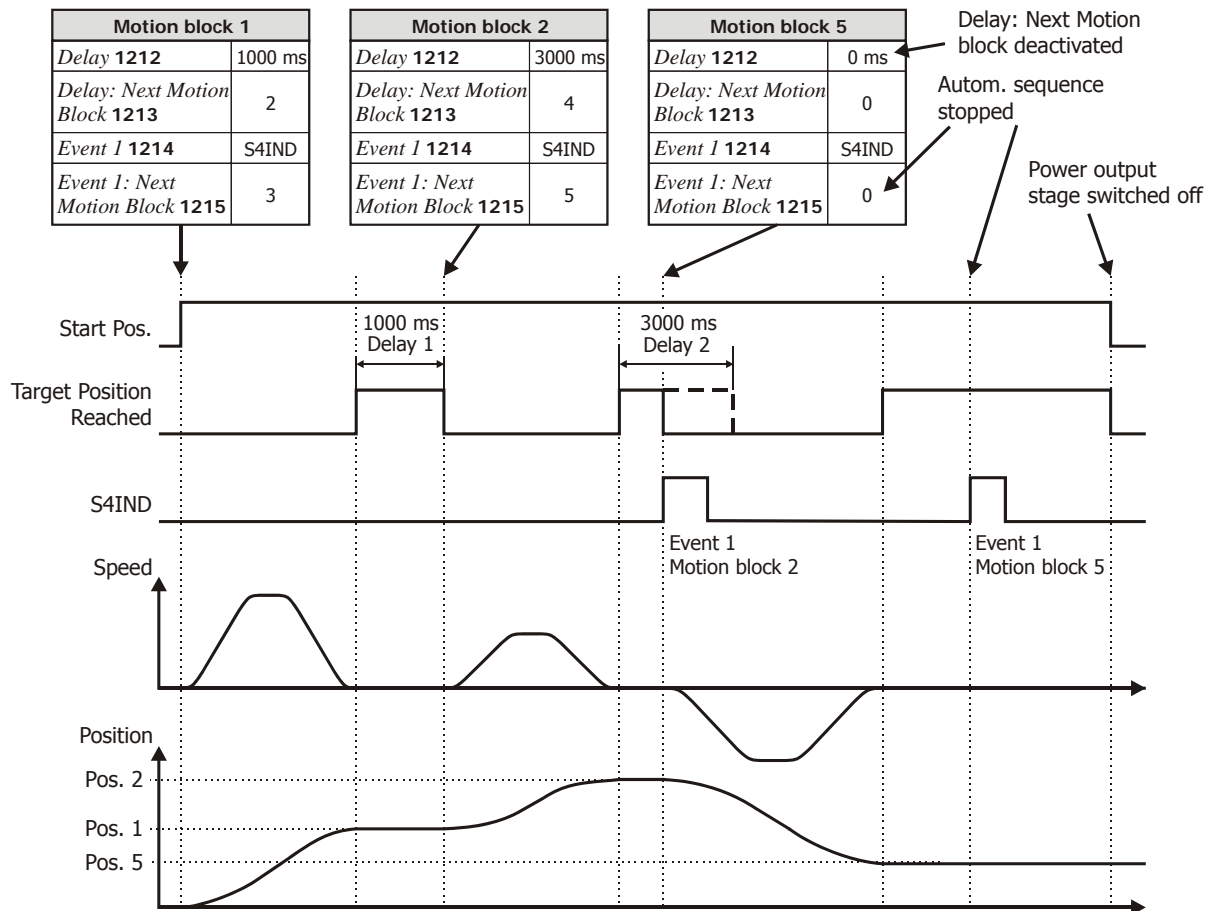

The current motion block can be displayed via parameter *Actual Motion Block 1246* or read via signal source "879 - Actual Motion Block" using the Scope function in the PC software VPlus.

Note: If event-controlled sequences and the settings for *Operation Mode 1221 = 11x* are used, note the settings in parameters 1212 to 1217 (delay, next motion block, event) in any case. Otherwise, the drive may jump between the first motion block points if the condition Next Motion Block = 0 is fulfilled and a restart of the positioning operation is triggered directly.

4.4.2.5 Single motion

A signal on *Start Positioning 1222* starts the *Starting Record Number 1228* (parameter *Operation Mode 1221* in setting "202- single motion, motion block from p. 1228") or the motion block set via parameters *Motion Block Change-Over 1 1224* to *Motion Block Change-Over 5 1254*, (parameter *Operation Mode 1221* in setting "201-single motion, motion block via digital inputs"). After completion of the motion, the target position is maintained.

If operation mode "Speed" or an operation mode with el. gearing is selected for *Motion Mode 1208*, the drive will continue to turn until the signal on *Start Positioning 1222* is reset or interrupted by a signal on *Stop Positioning 1223*.

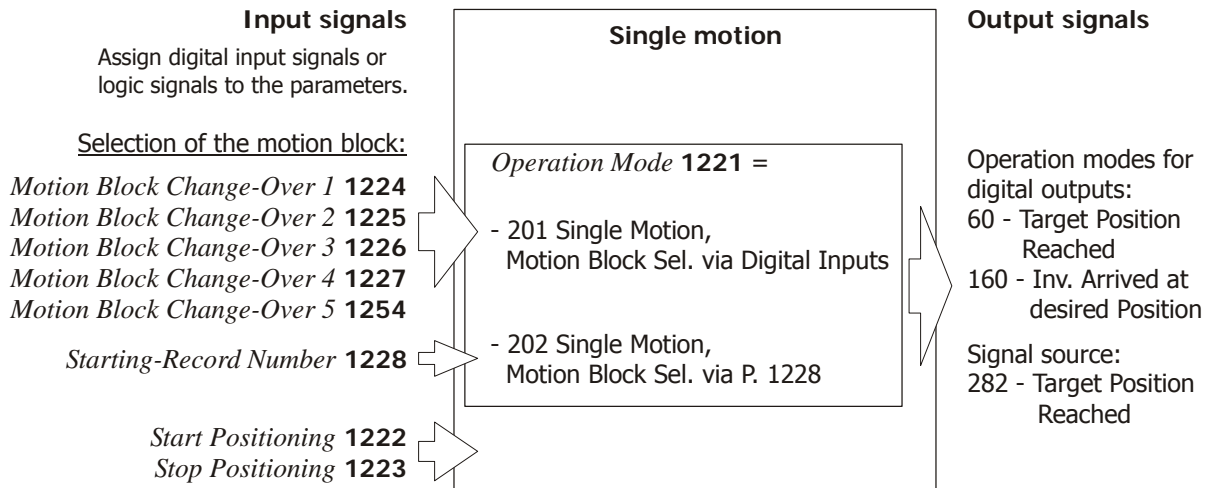

4.4.3 Control of motion

4.4.3.1 Selection of motion block via digital signals (motion block change-over)

If the motion blocks are selected via digital signals, motion blocks 1 to 32 can be selected via the motion block change-over function.

The motion block selection via digital inputs is active if parameter *Operation Mode 1221* is set to one of the following modes:

- 101 - Sequence Mode w/o Restart, 1st Motion Block via Digital Inputs
- 111 - Sequence Mode with Restart, 1st Motion Block via Digital Inputs
- 201 - Single Motion, Motion Block Sel. via Digital Inputs
- 301 - Teach-In, Motion Block Sel. via Digital Inputs

In operation modes 101, 111 and 201, the motion starts with the motion block selected via the digital inputs when a signal is present on the input for *Start Positioning 1222*.

In operation mode 301, the current position is saved as the *Target Position / Distance 1202* in the motion block selected via the digital inputs when a signal is present on input for *Teach-In-Signal 1239*.

Parameter		Factory setting
1224	Motion Block Change-Over 1	320 - EM-S1IND ¹⁾
1225	Motion Block Change-Over 2	321 - EM-S2IND ¹⁾
1226	Motion Block Change-Over 3	322 - EM-S3IND ¹⁾
1227	Motion Block Change-Over 4	7 - Off
1254	Motion Block Change-Over 5	7 - Off

¹⁾ Digital inputs of optional extension module

The motion block change-over function depends on the settings of parameter *Operation Mode 1221*:

<i>Operation Mode 1221</i>	Function
101 - Sequence Mode w/o Restart, 1st Motion Block via Digital Inputs	Signal on <i>Start Positioning 1222</i> starts the automatic sequence of motion blocks with the motion block selected by the motion block change-over function.
111 - Sequence Mode with Restart, 1st Motion Block via Digital Inputs	
201 - Single Motion, Motion Block Sel. via Digital Inputs	Signal on <i>Start Positioning 1222</i> starts the motion block selected by the motion block change-over function.
301 - Teach-In, Motion Block Sel. via Digital Inputs	Signal on <i>Teach-In Signal 1239</i> enters the current position in the motion block selected by the motion block change-over function as the target position. The target position is saved in parameter <i>Target Position / Distance 1202</i> .
0 - Off	Sequence Mode/Single Motion/Teach-In is switched off.
102 - 112 - 202 - 302 - 1000 -	In these settings the 1st motion block (sequence mode) or motion block (single motion/Teach-In) is not selected via the digital inputs for the motion block change-over. The motion blocks are selected via parameter <i>Starting-Record Number 1228</i> . Control by function table.

Input signals for motion block change-over

Input signals

Assign digital input signals to the parameters.

Motion Block selection

Motion Block Change-Over 1 **1224**

Motion Block Change-Over 2 **1225**

Motion Block Change-Over 3 **1226**

Motion Block Change-Over 4 **1227**

Motion Block Change-Over 5 **1254**

Motion Block Change-Over

In the settings of parameter *Operation Mode* **1221** =

101 - Sequence Mode w/o Restart, 1st Motion Block via Digital Inputs

111 - Sequence Mode with Restart, 1st Motion Block via Digital Inputs

201 - Single Motion, Motion Block Sel. via Digital Inputs

301 - Teach-In, Motion Block Sel. via Digital Inputs

Select one of the motion blocks 1 ... 32

Parameters *Motion Block Change-Over* (**1224 to 1227, 1254**) are binary encoded and are added via the value of the bits. Additionally, "1" is added for calculation of the motion block - motion block exists as an overriding motion block enabling parameter changes across all motion blocks at the same time.

Selection of motion blocks with motion block change-over function

Motion block change-over 1 1224	Motion block change-over 2 1225	Motion block change-over 3 1226	Motion block change-over 4 1227	Motion block change-over 5 1254	Motion block
2^0	2^1	2^2	2^3	2^4	$1+2^0+2^1+...$
0	0	0	0	0	1
1	0	0	0	0	2
0	1	0	0	0	3
1	1	0	0	0	4
0	0	1	0	0	5
1	0	1	0	0	6
0	1	1	0	0	7
1	1	1	0	0	8
0	0	0	1	0	9
1	0	0	1	0	10
0	1	0	1	0	11
1	1	0	1	0	12
0	0	1	1	0	13
1	0	1	1	0	14
0	1	1	1	0	15
1	1	1	1	0	16
0	0	0	0	1	17
1	0	0	0	1	18
0	1	0	0	1	19
1	1	0	0	1	20
0	0	1	0	1	21
1	0	1	0	1	22
0	1	1	0	1	23
1	1	1	0	1	24
0	0	0	1	1	25
1	0	0	1	1	26
0	1	0	1	1	27
1	1	0	1	1	28
0	0	1	1	1	29
1	0	1	1	1	30
0	1	1	1	1	31
1	1	1	1	1	32

4.4.3.2 Motion block selection via parameter (starting-record number)

Via parameter *Starting-Record Number 1228*, one of the 32 motion blocks can be selected.

The motion block selection via parameter is active if parameter *Operation Mode 1221* is set to one of the following modes:

- 102 - Sequence Mode with Restart, 1st Motion Block via P. 1228
- 112 - Sequence Mode with Restart, 1st Motion Block via P. 1228
- 202 - Single Motion, Motion Block Sel. via P. 1228
- 302 - Teach-In, Motion Block Sel. via P. 1228

In operation modes 102, 112 and 202, the motion starts with the motion block selected in parameter *Starting Record Number 1228* when a signal is present on the input for *Start Positioning 1222*.

In operation mode 302, the current position is saved as the *Target Position / Distance 1202* in the motion block set in parameter *Starting Record Number 1228* when a signal is present on input for *Teach-In-Signal 1239*.

Parameter		Setting		
No.	Description	Min.	Max.	Fact. sett.
1228	Starting-record number	1	32	1

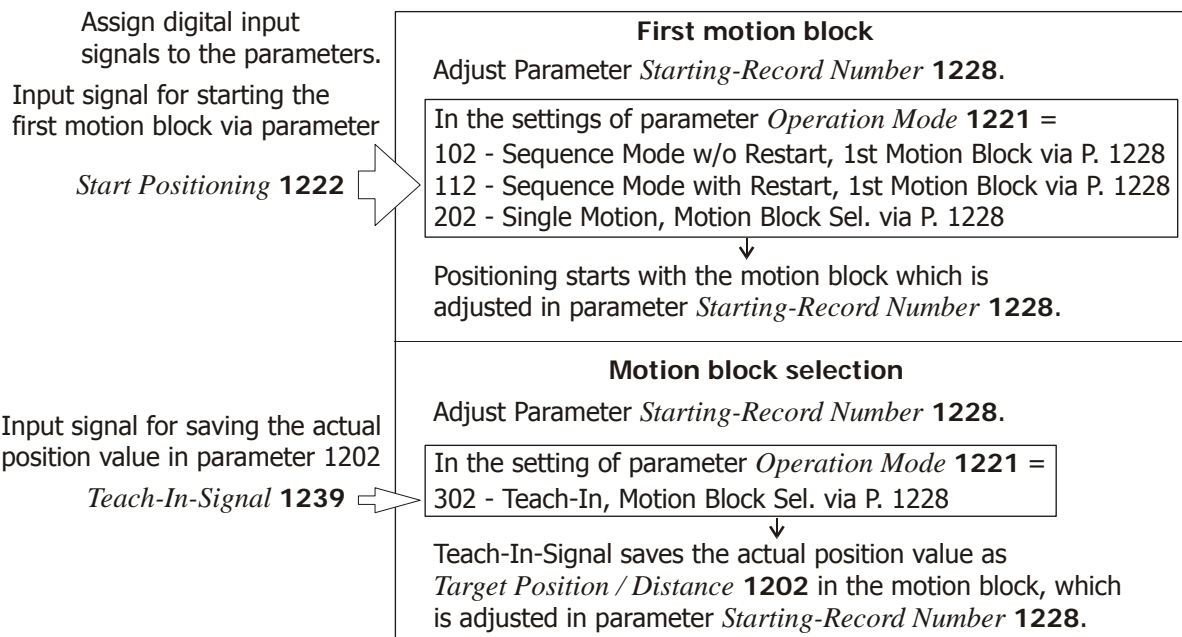

The function of the starting record depends on the settings of parameter *Operation Mode 1221*:

<i>Operation mode 1221</i>	Function
102 - Sequence Mode without Restart, 1st Motion Block via P. 1228	Signal on <i>Start Positioning 1222</i> starts the automatic sequence of motion blocks set in parameter <i>Starting Record Number 1228</i> .
112 - Sequence Mode with Restart, 1st Motion Block via P. 1228	
202 - Single Motion, Motion Block Sel. via P. 1228	Signal on <i>Start Positioning 1222</i> starts the motion block set in parameter <i>Starting Record Number 1228</i> .
302 - Teach-In, Motion Block Sel. via P. 1228	Signal on <i>Teach-In Signal 1239</i> enters the current position in the motion block selected in Parameter <i>Starting-Record Number 1228</i> as the target position. The target position is saved in parameter <i>Target Position / Distance 1202</i> .

4.4.4 Input and output signals for motion blocks

The controller enables the execution of individual orders, repetition of motion blocks and automatic sequence of motion blocks.
The motion block for the motion order can be selected via digital inputs or parameters. The terminal assignment (without selection of motion block) is shown in the following table.

Terminal assignment for motion mode						
Function	Control- ler re- lease	Start Position- ing 1222	Stop Position- ing 1223	Touch probe	Neg. HW Limit Switch 1137	Pos. HW Limit Switch 1138
		S2IND*	S3IND*	S3IND**	S5IND ³⁾	S4IND ³⁾
Drive dis- abled	0	X	X	X	0 (1)	0 (1)
Positioning is started and processed (4.4.5.1)	1	1	0	0	0 (1)	0 (1)
Touch probe event is processed (4.4.1.3)	1	1	0	edge (parameter 1208) ¹⁾	0 (1)	0 (1)
Positioning is stopped (4.4.5.1)	1	1	1	X	0 (1)	0 (1)
Error message, limit switch as make contact function (<i>brake contact function</i>)						
F1445 ²⁾	X	X	X	X	1 (0)	1 (0)
F1447 (F1446) ²⁾	X	X	X	X	0 (1)	1 (0)
F1448 (F1446) ²⁾	X	X	X	X	1 (0)	0 (1)

0 = Low / 1 = High / X = any / * = factory setting

** = When the touch probe input (S3IND fixed) is used, parameterization of *Stop Positioning 1223* (factory setting S3IND) must be changed.

¹⁾ Setting of *Motion Mode 1208* = 2, 3, 12 or 13

²⁾ Also refer to chapter "Positioning Error Messages"
 F1445: Pos. and Neg. HW-Lim Switch Simultaneously
 F1446: Limit Switch Incorrect Wired
 F1447: Pos. HW Limit Switch
 F1448: Neg. HW Limit Switch

³⁾ Dependent on *Operation Mode 490*. Comply with the instructions in sections 3.4 and 3.5.1.4.
Assign S4IND and S5IND to the parameters for HW limit switches.

Values in parentheses (0) and (1) apply if the digital inputs for the limit switches are configured as inverted inputs (*brake contact function*), e.g. *Positive HW Limit Switch 1138* = "540 - S4IND inverted (Hardware)".

Note: For controller release of the power component, wiring of the following digital inputs is required:
 STOA (terminal X210A.3) and STOB (terminal X210B.2).

In safety-oriented systems, the documentation "Safe Torque Off" shall be complied with.

Note: Before a positioning operation can be started, the point of reference of the positioning operation must be identified in a homing operation. Otherwise, error message "F1570 – No Homing Done" will be displayed if you try to start a positioning operation.

4.4.5 Starting, stopping and resuming

The processing of a parameterized positioning sequence can be started and stopped by 3 digital signals. The following table summarizes the control options. The significant signal is marked bold.

Mode	Start	Stop	Resume	Description
Normal	1	0	0	The motion blocks are executed in the parameterized order.
Stop	1	1	0	As soon as the stop signal is present the drive will be stopped with <i>Deceleration 1206</i> . If the stop signal is resetted the drive will proceed at the cancelled position.
Cancel	1→0	X	0	As soon as the start signal is resetted the positioning sequence will be cancelled and the drive will be stopped with <i>Deceleration 1202</i> . If the start signal is set again the positioning starts with the starting-record number.
Resume	1	0	1	If a positioning sequence is cancelled the resume function allows the proceeding of the sequence at the last position (instead of the starting-record number). Therefore first set the resume signal and then set the start signal.

Consult the following chapters for a detailed description.

4.4.5.1 Starting and stopping positioning

The positioning operation is controlled via signals for both parameters *Start Positioning 1222* and *Stop Positioning 1223*. The parameters can be assigned logic signals or digital inputs. The positioning operation is started with a positive edge on digital input or a logic signal for parameter *Start Positioning 1222* (factory setting S2IND). The logic signals for motion block change-over are evaluated only when a signal for parameter *Start Positioning 1222* is present. Via *Operation Mode 1221*, it is defined if a single motion or an automatic sequence is started. After completion of an automatic motion block sequence, a restart can be performed. *Operation Mode 1221* defines the action after start positioning and the motion block selection.

Operation Mode 1221:

- automatic sequence or single motion
- restart after automatic sequence
- first motion block for automatic sequence via motion block change-over function or via parameter *Starting-Record Number 1228*
- motion block for single motion via motion block change-over function or via parameter *Starting-Record Number 1228*

If the signal for "Stop Positioning" is set during a motion order, the drive will stop at the current position at the *Deceleration 1206* set in the current motion block. As soon as "Stop Positioning" is reset, the motion block is continued.

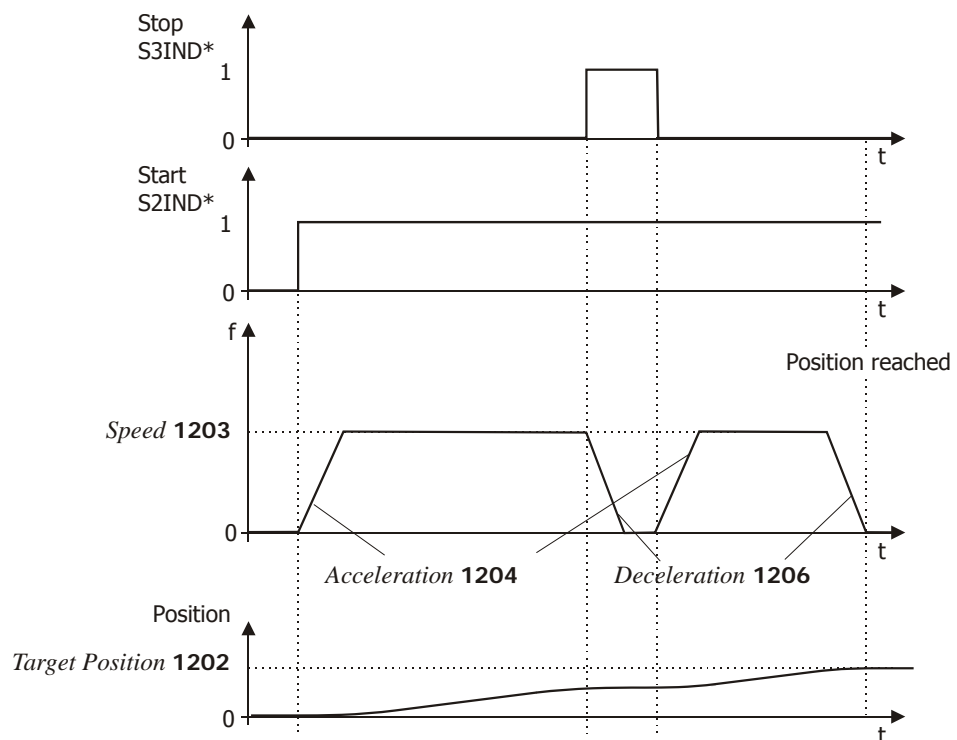

* Factory setting

If the signal for "Start Positioning" is reset during a motion order, the drive will stop at the current position at the *Deceleration 1206* set in the active motion block. If "Start Positioning" is set again the sequence of motion blocks begins with the 1st motion block. If the time set in parameter *Holding Time 638* is exceeded, the drive is switched off.

Parameter		Factory setting	
1222	Start Positioning	71 -	S2IND
1223	Stop Positioning	72 -	S3IND

A motion block can be started with "Start Positioning" even if the "Holding Time" is not elapsed.

Input signals for starting and stopping motion block sequences or single motions

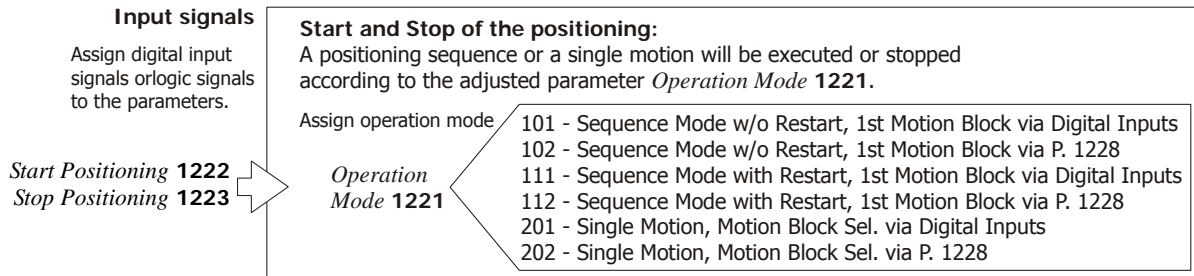

Note: Before a positioning operation can be started, the point of reference of the positioning operation must be identified in a homing operation. Otherwise, error message "F1570 – No Homing Done" will be displayed if you try to start a positioning operation.

Example:

In an application, the position in motion block 1 is approached first after activation. Motion block 1 is set in *Starting-Record Number 1228*. Then, the absolute target positions 2, 3 and 4 are approached continuously according to the parameter configuration. If the start signal is reset and started again, the sequence starts again with motion block 1. If, however, the stop signal is received, the operation is stopped as long as the stop signal is present.

Example: Motion profile

<i>Starting-Record Number 1228</i>	1
Next motion block ¹⁾ [index 1]	2
Next motion block ¹⁾ [index 2]	3
Next motion block ¹⁾ [index 3]	4
Next motion block ¹⁾ [index 4]	2

¹⁾ Possible parameters for setting of next motion block:

Delay: Next Motion Block 1213,
Event 1: Next Motion Block 1215,
Event 2: Next Motion Block 1217,
Int.-Event 1: Next Motion Block 1262,
Int.-Event 2: Next Motion Block 1265

According to the example above: Reaction of the drive on set "Stop Positioning" and reset "Start Positioning"

- Reaction on set "Stop Positioning" (example)

Distance-time and velocity-time diagrams

Starting-Record Number 1228 1

Motion Blocks	Index 1	Index 2	Index 3	Index 4
Target Position	TP 1	TP 2	TP 3	TP 4
Next Motion Block	2	3	4	2

TP: Target Position value

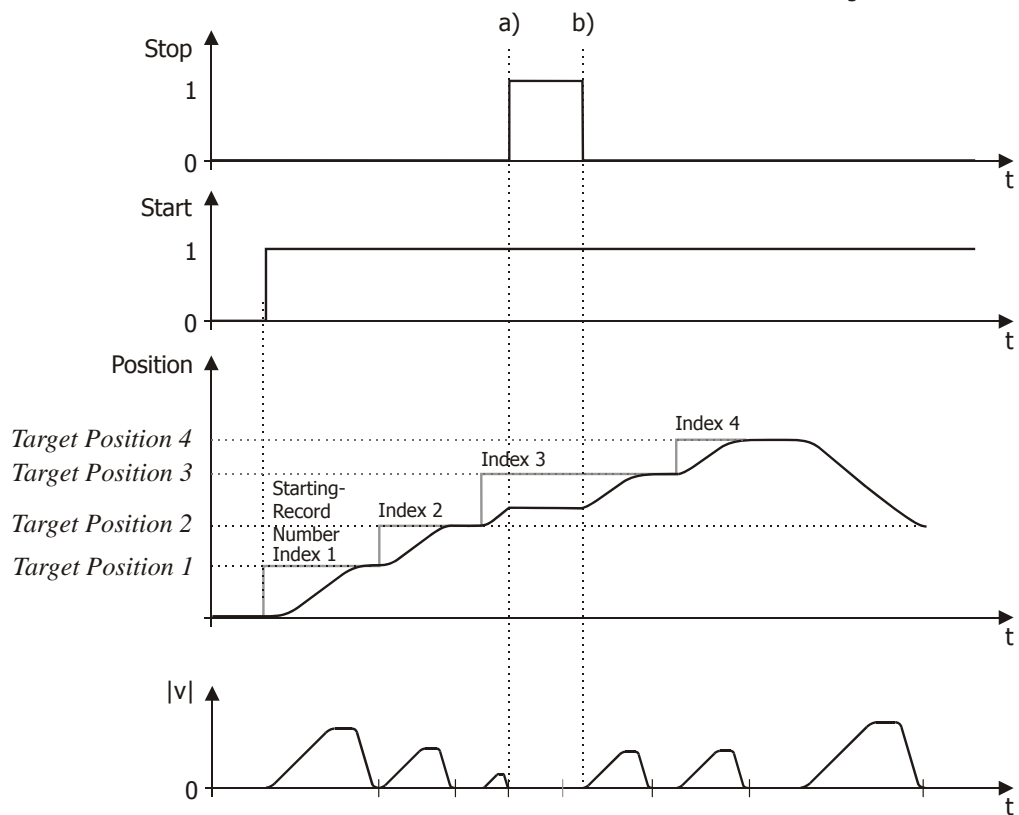

- a) Set "Stop positioning":
The drive decelerates and stops immediately with *Deceleration 1206*.
- b) Reset "Stop Positioning":
The current motion block will be continued.

- Reaction on reset "Start Positioning" (example)

Distance-time and velocity-time diagrams

Starting-Record Number **1228** 1

Motion Blocks	Index 1	Index 2	Index 3	Index 4
Target Position	TP 1	TP 2	TP 3	TP 4
Next Motion Block	2	3	4	2

TP: Target Position value

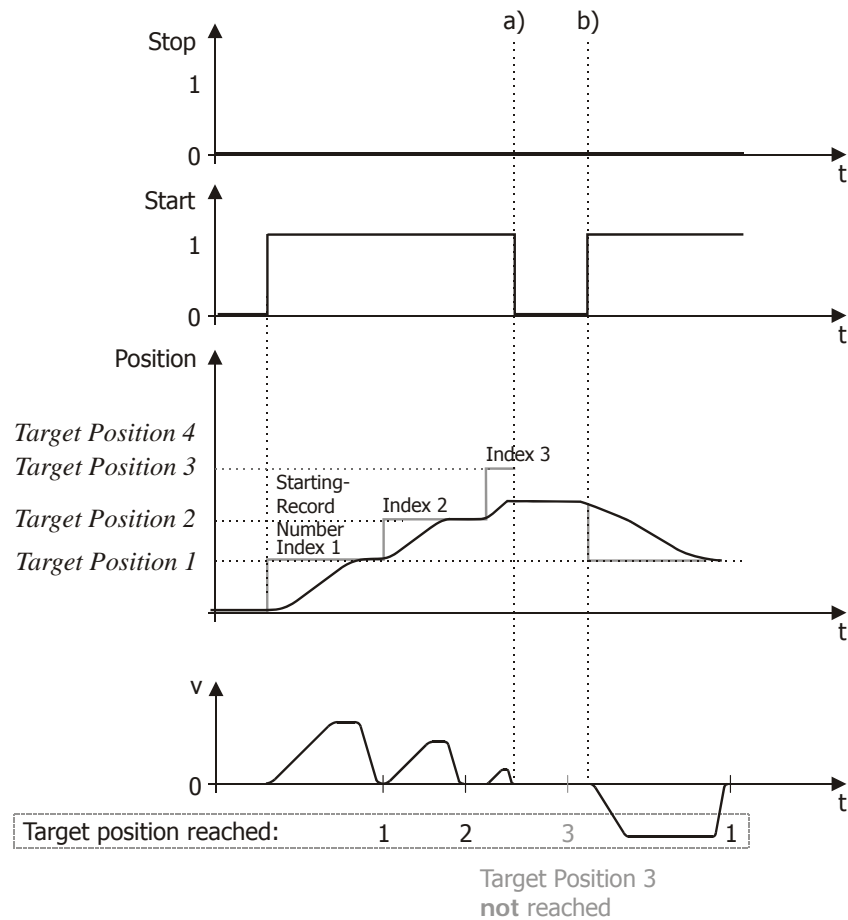

- a) Reset "Start Positioning":
The drive decelerates and stops immediately with *Deceleration 1206*.
- b) Set "Start Positioning" again:
The drive moves to the target position 1 from *Starting-Record Number 1228*.

4.4.5.2 Resuming interrupted motion blocks

The resume function enables continuing motion blocks after an interruption by an error or by resetting of the "Start Positioning" signal.

Resumption is effected as follows:

1. Set signal on the input assigned to parameter *Resume Motion Block* **1230**.
2. Set Signal *Start Positioning* **1222**

The resumed motion block is indicated by parameter *Motion Block to Resume* **1249**.

Note: The resume is deactivated while the teach-in function is being carried out. In this case, *Motion Block to Resume* **1249** has the value -1.

In the case of an absolute positioning operation, the target position for resumption is taken over from the interrupted motion block directly.

In the case of a relative positioning operation, the target position for resumption is calculated from the target position saved in the motion block and the current position at the time the motion block is started.

Example: Resumption in the case of relative positioning operation

The current position is 10000 u. A distance of 20000 u is to be covered. After the start of the motion block, an error occurs and the drive stops at position 15000. To resume this motion block, the absolute target position of 30000 u is calculated, i.e. 10000 u (actual position at start of motion block) + 20000 u (distance from motion block). Positioning is started in absolute motion mode.

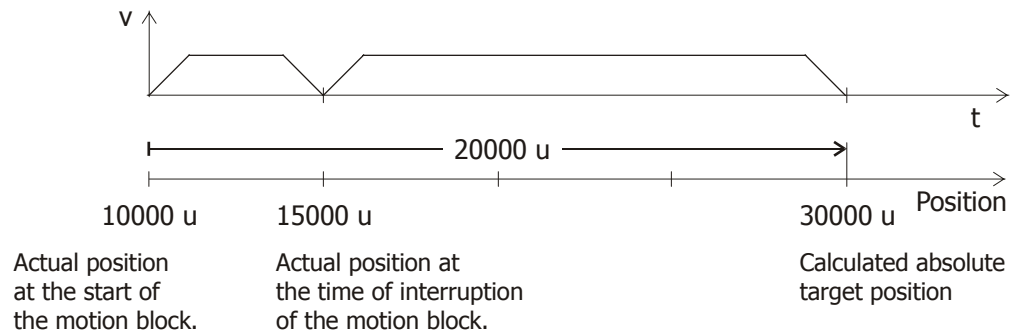

When the power supply is turned off, the last actual position of the drive is saved. Except for the settings of *Operation Mode* **1220** = "2 - automatic" (automatic start of homing) and additional *Homing Mode* **1130** = "35 - Current Position" (current position is home position).

4.4.6 Digital signals for indication of status of motion orders

For each motion block, there are 4 digital signals which are influenced depending on the status of the motion order and can be used for indicating the status of motion orders:

Digital Signal 1 **1218**

Digital Signal 2 **1219**

Digital Signal 3 **1247**

Digital Signal 4 **1248**

To control logic functions or for transmission via the system bus (available if extension module with system bus interface is connected) the following signals can be selected:

891 – Motion-Block Digital Signal 1

892 – Motion-Block Digital Signal 2

893 – Motion-Block Digital Signal 3

894 – Motion-Block Digital Signal 4

895 – Motion-Block Digital Signal 1 inverted

896 – Motion-Block Digital Signal 2 inverted

897 – Motion-Block Digital Signal 3 inverted

898 – Motion-Block Digital Signal 4 inverted

Operation modes for digital outputs:

62 – Motion-Block Digital Signal 1

63 – Motion-Block Digital Signal 2

64 – Motion-Block Digital Signal 3

65 – Motion-Block Digital Signal 4

162 – Motion-Block Digital Signal 1 inverted

163 – Motion-Block Digital Signal 2 inverted

164 – Motion-Block Digital Signal 3 inverted

165 – Motion-Block Digital Signal 4 inverted

The statuses of the digital signals can be influenced (set, reset or leave unchanged) when the following events occur:

- Reference value reached
- Start of motion block
- End of motion block

Digital output signals of motion blocks

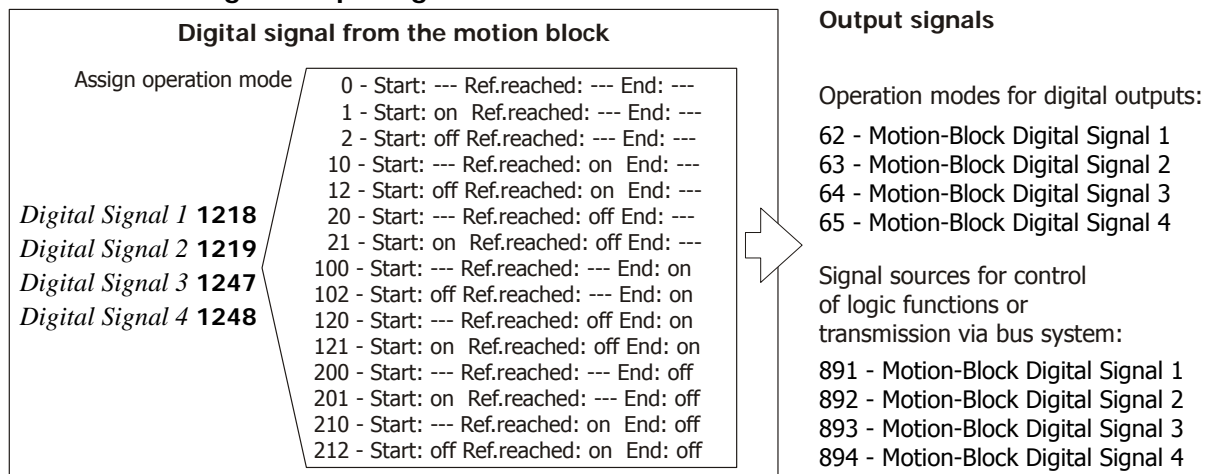

The operation mode is the result of the combination of 3 possible input signals and 3 status changes to produce the required output signal. The unit digit defines the evaluation upon the start of the motion block, the tens digit defines the evaluation as soon as the reference value is reached and the hundreds digit defines the evaluation at the end of the motion block.

Signal	Operation mode		
	Start	Reference value reached	End
unchanged	_0	_0	0__
On	_1	_1	1__
Off	_2	_2	2__

Note: The underscore characters "_" are used as wildcards so that it can be seen directly for which place (unit, tens, hundreds digit) the value is used.

Start

"Start" is evaluated when a positioning operation starts.

Reference value reached

The evaluation of "Reference value reached:" depends on the parameter configuration for *Motion Mode 1208*:

<i>Motion Mode 1208</i>	Evaluation of "Reference value reached":
0 - absolute 1 - relative 2 - Touch probe: rising edge 3 - Touch probe: falling edge 10 - Gearing, absolute 11 - Gearing, relative 12 - Gearing, touch probe: rising edge 13 - Gearing, touch probe: falling edge 20 - Gearing, direct sync., absolute 21 - Gearing, direct sync., relative 22 - Gearing, direct sync., Touch-Probe: Rising Edge 23 - Gearing, direct sync., Touch-Probe: Falling Edge	Evaluation of "Reference value reached:" if <i>Target Position / Distance 1202</i> is reached.
4 - Velocity	Evaluation of "Reference value reached:" if <i>Speed 1203</i> is reached.
14 - Gearing 24 - Gearing, direct synchronisation	Evaluation of "Reference value reached:" when master speed is reached and logic signal "57 – In Gear" is set.

End

The evaluation of "End:" depends on the parameter configuration for *Operation Mode 1221*:

<i>Operation mode 1221</i>	Evaluation of "End":
Automatic sequence	Evaluation of "End:" after completion of motion block.
Single motion	No evaluation of "End": The digital signal corresponds to the status "Reference value reached:". The status depends on the selected operation mode for the digital signal (parameter 1218, 1219, 1247, 1248). Possible statuses: "off", "on" or "unchanged".

Example 1:

Digital signal 3 is to indicate that the target position was reached. When the position is reached, the output signal is to be "1". When the position is not reached, the output signal is to be "0".

As soon as the target position is reached, the output is to be switched on, i.e. tens digit is 1. When the motion block is started, it is assumed that the target position has not been reached, i.e. unit digit is 2. At the end of the motion block, the target position is unchanged; i.e. hundreds digit 02. If you combine these digits you get Operation Mode 012.

For this reason parameter *Digital Signal 3* **1247** = 12.

Example 2: Operation mode 120 for parameter *Digital Signal 1* 1218

1. Digital signal 1 (signals "62 – Motion Block Digital Output 1" and "891 – Motion Block Digital Output 1") remains unchanged when the motion block starts.
2. Digital signal 1 is reset when the target position is reached.
3. Digital signal 1 is set at the end of the motion block (incl. delay).

Motion block 1	
<i>Delay</i> 1212	1000 ms
<i>Delay: Next Motion Block</i> 1213	2
<i>Digital Signal 1</i> 1218	120 - Start: --- Ref.reached: off End: on

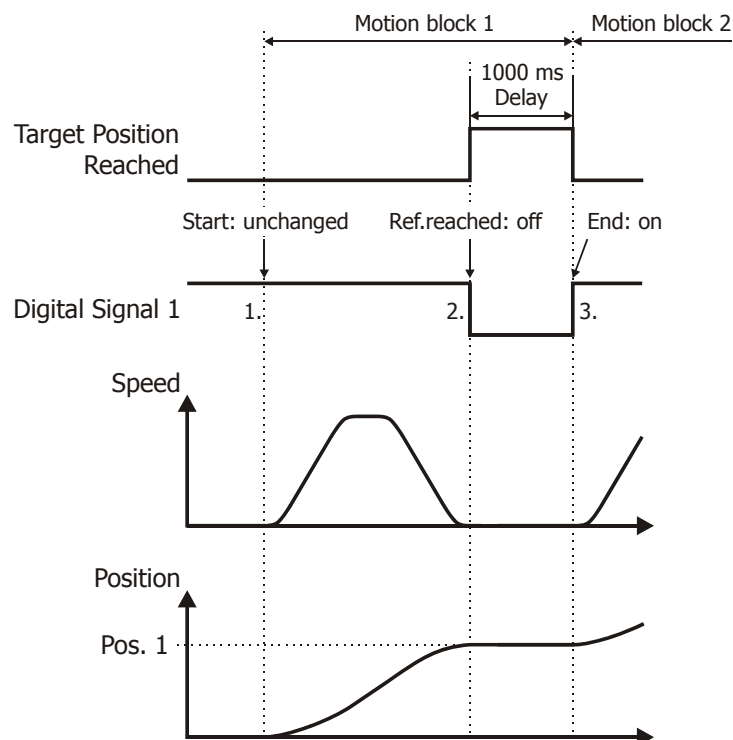

4.5 JOG Mode

For commissioning and teach-in mode, the drive can also be controlled manually via digital inputs. JOG mode offers various options:

- The drive is moved clockwise or anticlockwise, via two digital inputs in each direction
- 4 fixed speeds available in each of 4 data sets; selection via reference frequency channel
- Control possible via buttons of control unit
- Separate acceleration and deceleration ramps
- Approaching of positions to be saved as target positions in motion blocks. This function is available in teach-in mode.
- Moving without automatic sequence for commissioning and service

Input signals for JOG mode:

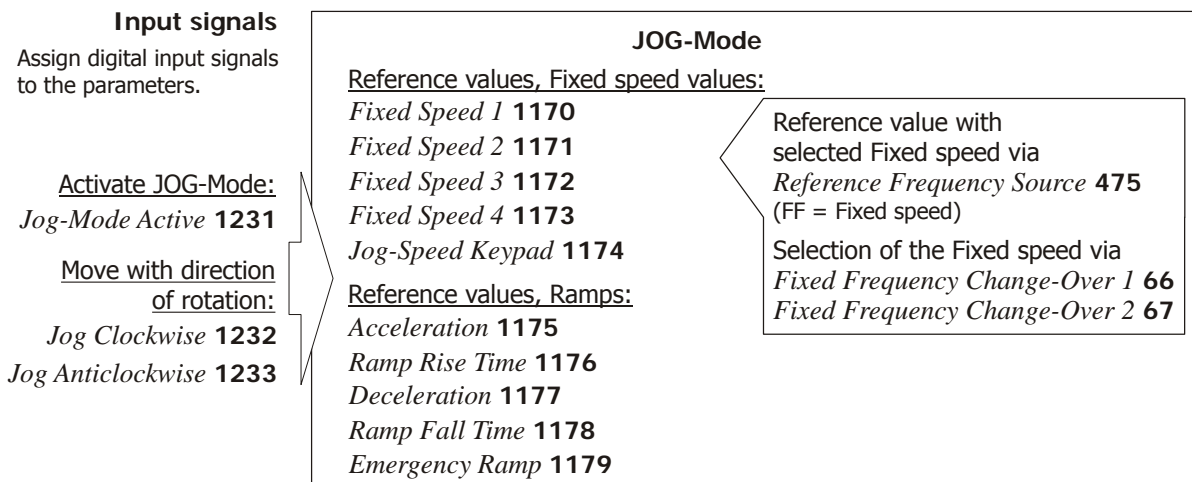

Via *Jog-Mode Active* **1231**, the JOG function is activated. Via signal *Jog Clockwise* **1232** or *Jog Anticlockwise* **1233**, the drive is moved in clockwise/anticlockwise direction at the required speed. The speed is defined via the reference frequency channel with parameter *Reference Frequency Source* **475**. For parameter *Reference Frequency Source* **475**, an operation mode with fixed speed (FF) must be selected. One of the four fixed speeds can be selected via parameters *Fixed Frequency Change-over 1* **66** and parameter *Fixed Frequency Change over 2* **67**.

Parameter	Factory setting
1231 Jog-Mode Active	76 - MFI1D
1232 Jog Clockwise	71 - S2IND
1233 Jog Anticlockwise	72 - S3IND

Standard Terminal Assignment JOG mode

Function	Control- ler re- lease	Jog- Mode Active 1231 MFI1D*	Jog Clock- wise 1232 S2IND*	Jog Anti- clockwise 1233 S3IND*	Neg. HW Limit Switch 1137 S5IND ²⁾	Pos. HW Limit Switch 1138 S4IND ²⁾
Drive dis- abled	0	X	X	X	0 (1)	0 (1)
Drive dis- abled	X	1	1	1	0 (1)	0 (1)
JOG mode clockwise	1	1	1	0	0 (1)	0 (1)
JOG mode anticlock- wise	1	1	0	1	0 (1)	0 (1)
Error message, limit switch as make contact function (brake contact function)						
F1445 ¹⁾	X	X	X	X	1 (0)	1 (0)
F1447 (F1446) ¹⁾	X	X	X	X	0 (1)	1 (0)
F1448 (F1446) ¹⁾	X	X	X	X	1 (0)	0 (1)

0 = Low / 1 = High / X = any / * = factory setting

- ¹⁾ Also refer to chapter "Positioning Error Messages"
 F1445: Pos. and Neg. HW-Lim Switch Simultaneously
 F1446: Limit Switch Incorrect Wired
 F1447: Pos. HW Limit Switch
 F1448: Neg. HW Limit Switch

- ²⁾ Dependent on *Operation Mode 490*. Comply with the instructions in sections 3.4 and 3.5.1.4.
 Assign S4IND and S5IND to the parameters for HW limit switches.

Values in parentheses (0) and (1) apply if the digital inputs for the limit switches are configured as inverted inputs (*brake contact function*), e.g. *Positive HW Limit Switch 1138* = "540 - S4IND inverted (Hardware)".

Note: JOG mode can be started without homing. The hardware limit switches are active; the software limit switches relate to the reference position and are active only after a homing operation.

Input terminals for JOG mode:

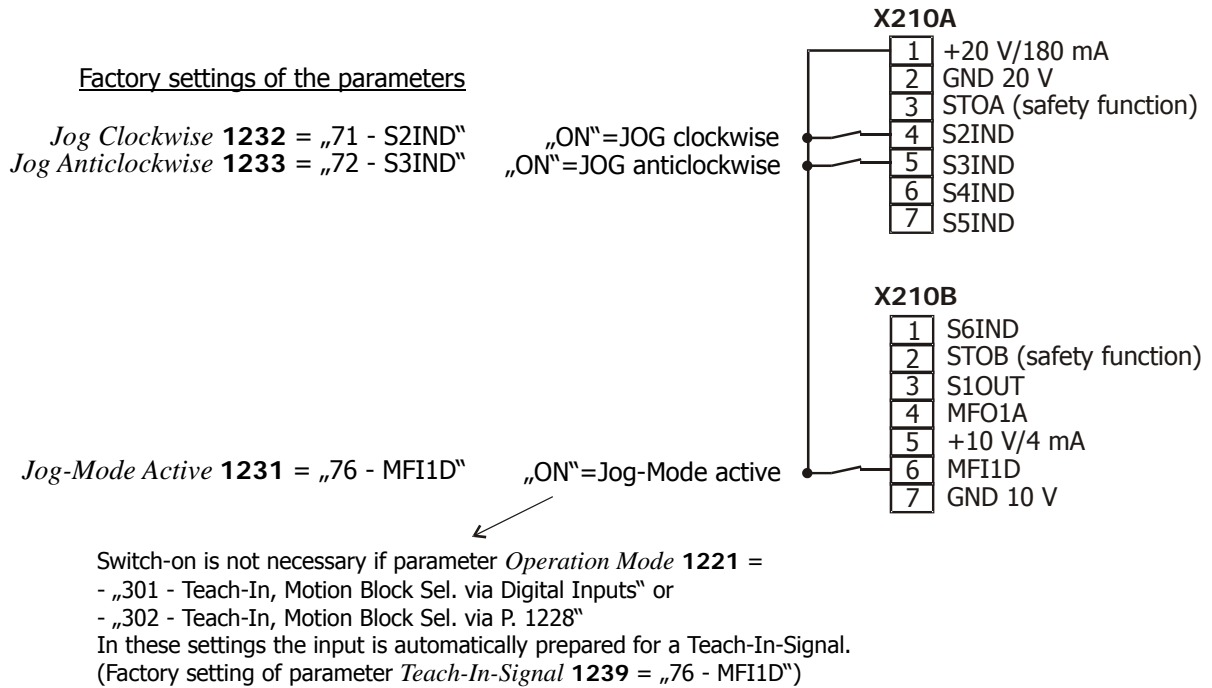

Note: For release of the power component, wiring of the following digital inputs is required:
 STOA (terminal X210A.3) and STOB (terminal X210B.2).

In safety-oriented systems, the documentation "Safe Torque Off" shall be complied with.

4.5.1 Fixed speed in JOG mode

Four fixed speeds can be used in JOG mode. The fixed speed to be used can be selected via parameter *Reference Frequency Source* **475** of the reference frequency channel. For parameter *Reference Frequency Source* **475**, an operation mode with fixed speed (FF/fixed frequency) must be selected. Via the logic states of the signals assigned to parameters *Fixed Frequency Change-Over 1* **66** and *Fixed Frequency Change-Over 2* **67**, one of the four fixed speeds can be selected. Parameters *Fixed Frequency Change-Over 1* **66** and *Fixed Frequency Change-Over 2* **67** must be assigned digital input signals or logic signals (factory setting: digital inputs EM-S1IND and EM-S2IND of an optional extension module).

Parameter		Setting		
No.	Description	Min.	Max.	Fact. sett.
1170	Fixed Speed 1	$-(2^{31}-1)$ u/s	$2^{31}-1$ u/s	163840 u/s
1171	Fixed Speed 2	$-(2^{31}-1)$ u/s	$2^{31}-1$ u/s	327680 u/s
1172	Fixed Speed 3	$-(2^{31}-1)$ u/s	$2^{31}-1$ u/s	655360 u/s
1173	Fixed Speed 4	$-(2^{31}-1)$ u/s	$2^{31}-1$ u/s	1310720 u/s
1174	Jog-Speed Keypad	$-(2^{31}-1)$ u/s	$2^{31}-1$ u/s	163840 u/s

Selection of fixed speed		
<i>Fixed frequency change-over 1</i> 66	<i>Fixed frequency change-over 2</i> 67	Selected fixed speed (FF)
0	0	<i>Fixed Speed 1</i> 1170
1	0	<i>Fixed Speed 2</i> 1171
1	1	<i>Fixed Speed 3</i> 1172
0	1	<i>Fixed Speed 4</i> 1173

Selection of fixed speed for JOG mode:

- Set one or several of parameters *Fixed Speed 1* **1170** to *Fixed Speed 4* **1173**.
- Assign digital inputs or logic signals to parameters **66** and *Fixed Frequency Change-Over 2* **67**. Via the logic states of the input signals, select a fixed speed.
- For parameter *Reference Frequency Source* **475**, set an operation mode with fixed speed (FF), e.g. "10 – Abs. Val. Fixed Frequency (FF)".

When a digital signal is present for *Jog Mode Active* **1231** and *Jog Clockwise* **1232** or *Jog Anticlockwise* **1233**, the drive moves at the selected speed.

JOG mode via keypad can be activated:

- Navigate to the CTRL menu.
- Actuate the ENT-key. Signal CTRL flashes.
- Actuate the ENT-key again to reach the local operation mode (stopped).
- Use the FUN-key to travel with *Jog-Speed Keypad 1174*. While the key is actuated the drive runs. If the key is not actuated any more the drive will be stopped at the deceleration ramp.
- Use the ENT-key to change the direction of rotation. The direction of rotation is indicated at the display via an arrow and „F“ (Forward) or „R“ (Reverse). The direction of rotation can be changed at standstill or during travel operations.

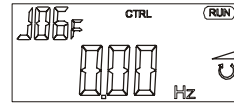
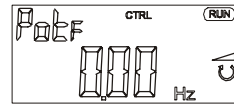
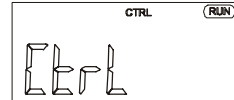

Warning! The RUN-key of the keypad allows manual operation in all configurations. This manual operation uses the fixed speed as the reference value. Direction of rotation and travel speed of both modes can be different. If you use the manual operation pay attention to the parameter settings.

4.5.2 Acceleration and Deceleration in JOG Mode

In JOG mode separate acceleration and deceleration ramps with S curves (ramp times) are used:

Parameter		Setting		
No.	Description	Min.	Max.	Fact. sett.
1175	Acceleration	1 μs^2	232-1 μs^2	327680 μs^2
1176	Ramp Rise Time	0 ms	2000 ms	0 ms
1177	Deceleration	1 μs^2	232-1 μs^2	327680 μs^2
1178	Ramp Fall Time	0 ms	2000 ms	0 ms
1179	Emergency Ramp	1 μs^2	$2^{32}-1 \mu\text{s}^2$	655360 μs^2

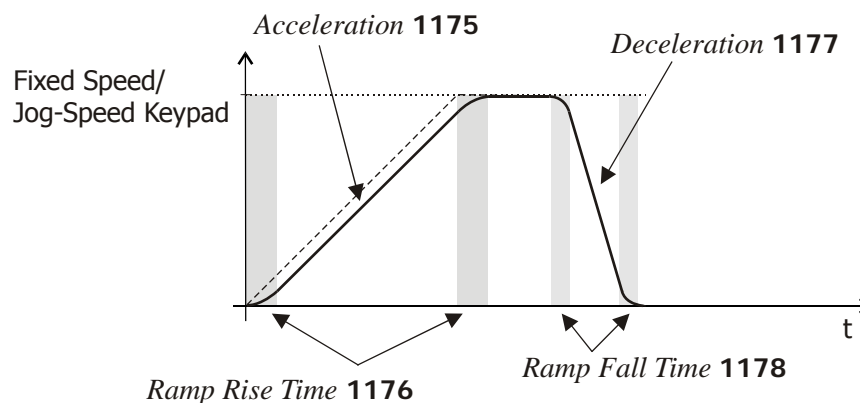

4.6 Teach-In (Saving Actual Position as Target Position)

The "Teach-In" function is used in order to approach the target positions in a plant manually and to save the corresponding position values in the motion blocks. The function works like the JOG function, with the following differences:

- Teach-In is activated via parameter *Operation Mode 1221*.
- By default, input MFI1D (Terminal X210B.6) is used for the teach-in signal.

How teach-in works:

- Set the motion block to be parameterized via digital inputs or parameter *Starting-Record Number 1228*.
- Move to required target position in JOG mode.
- Save actual position for the selected motion block via *Teach-In Signal 1239*.
- Repeat procedure for other positions.
- JOG mode is activated automatically in teach-in mode (parameter *Operation Mode 1221*).

Note: The first two steps of the sequence above can be executed vice versa.

Activate "Teach-In" function:

Set parameter *Operation Mode 1221* to:

- "301 - Teach-In, Motion Block Sel. via Digital Inputs" or
- "302 - Teach-In, Motion Block Sel. via P. 1228"

Input signals for teach-in

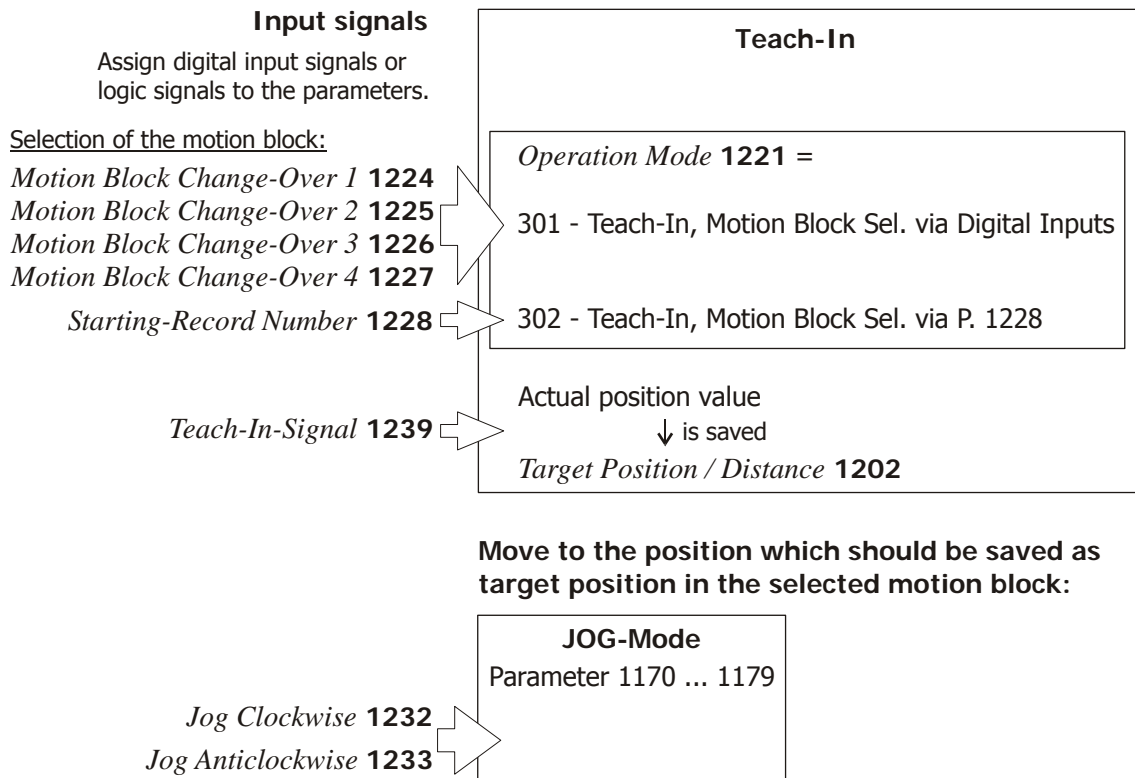

Approached positions can be entered in a motion block directly.
 The drive can be moved to the required position using the JOG function.

- clockwise (factory setting: digital input S2IND):
parameter *Jog Clockwise* **1232**
- anticlockwise (factory setting: digital input S3IND):
parameter *Jog Anticlockwise* **1233**

Setting of parameter *Jog-Mode Active* **1231** is not required in Teach-In mode.

As soon as parameter *Teach-In-Signal* **1239** receives a positive signal edge via a logic input signal (factory setting MFI1D), the current position is entered in the current motion block as a target position. The current motion block is defined by parameter *Starting-Record Number* **1228** or the motion block change-over function (parameters 1224 to 1227, 1254).

Note: In order to achieve maximum accuracy, move drive to required position, stop drive and set teach-in signal when drive has stopped.

In teach-in operation modes (parameter *Operation Mode* **1221**), the JOG function is activated automatically. In this case, signals on input for *Jog-Mode Active* **1231** will not be processed.

Parameter	Factory setting
1239 Teach-In-Signal	76 - MFI1D

Standard terminal assignment in teach-in mode

Function	Control- ler re- lease	Jog Clockwise 1232	Jog Anti- clock- wise 1233	Teach-In Signal 1239	Neg. HW Limit Switch 1137	Pos. HW Limit Switch 1138
		S2IND*	S3IND*	MFI1D*	S5IND ²⁾	S4IND ²⁾
Drive dis- abled	0	X	X	0	0 (1)	0 (1)
Drive dis- abled	X	1	1	X	0 (1)	0 (1)
JOG mode clockwise	1	1	0	0	0 (1)	0 (1)
JOG mode anticlock- wise	1	0	1	0	0 (1)	0 (1)
Position is saved	X	X	X	1 (positive edge)	0 (1)	0 (1)
Error message, limit switch as make contact function (<i>brake contact function</i>)						
F1445 ¹⁾	X	X	X	X	1 (0)	1 (0)
F1447 (F1446) ¹⁾	X	X	X	X	0 (1)	1 (0)
F1448 (F1446) ¹⁾	X	X	X	X	1 (0)	0 (1)

0 = Low / 1 = High / X = any / * = factory setting

- ¹⁾ Also refer to chapter "Positioning Error Messages"
 F1445: Pos. and Neg. HW-Lim Switch Simultaneously
 F1446: Limit Switch Incorrect Wired
 F1447: Pos. HW Limit Switch
 F1448: Neg. HW Limit Switch

- ²⁾ Dependent on *Operation Mode 490*. Comply with the instructions in sections 3.4 and 3.5.1.4.
 Assign S4IND and S5IND to the parameters for HW limit switches.

Values in parentheses (0) and (1) apply if the digital inputs for the limit switches are configured as inverted inputs (*brake contact function*), e.g. *Positive HW Limit Switch 1138* = "540 - S4IND inverted (Hardware)".

Input terminals for teach-in

Factory settings of the parameters

Jog Clockwise 1232 = „71 - S2IND“
Jog Anticlockwise 1233 = „72 - S3IND“

„ON“=JOG clockwise
 „ON“=JOG anticlockwise

Teach-In-Signal 1239 = „76 - MFI1D“

„ON“= Save the
 actual position value in
Target Position / Distance 1202

X210A

1	+20 V/180 mA
2	GND 20 V
3	STOA (safety function)
4	S2IND
5	S3IND
6	S4IND
7	S5IND

X210B

1	S6IND
2	STOB (safety function)
3	S1OUT
4	MFO1A
5	+10 V/4 mA
6	MFI1D
7	GND 10 V

Selection of motion blocks for teach-in

Selection of motion block where the current position is to be saved as a target position:

Operation mode 1221	Selected motion block						
301 - Teach-In, Motion Block Sel. via Digital Inputs	The current position is saved as the <i>Target Position / Distance</i> 1202 in the motion block selected by the motion block change-over function. Motion block change-over is effected through digital inputs assigned to the following parameters: – <i>Motion block change-over 1</i> 1224 – <i>Motion block change-over 2</i> 1225 – <i>Motion block change-over 3</i> 1226 – <i>Motion block change-over 4</i> 1227 – <i>Motion block change-over 5</i> 1254	Parameter Motion Block Change-Over					Motion Block $1+2^0+2^1+2^2+2^3+2^4$
		1224 2 ⁰	1225 2 ¹	1226 2 ²	1227 2 ³	1254 2 ⁴	
		0	0	0	0	0	1
		1	0	0	0	0	2
		0	1	0	0	0	3
		1	1	0	0	0	4
		0	0	1	0	0	5
		1	0	1	0	0	6
		0	1	1	0	0	7
		1	1	1	0	0	8
		0	0	0	1	0	9
		1	0	0	1	0	10
		0	1	0	1	0	11
		1	1	0	1	0	12
		0	0	1	1	0	13
		1	0	1	1	0	14
		0	1	1	1	0	15
		1	1	1	1	0	16
		0	0	0	0	1	17
		1	0	0	0	1	18
		0	1	0	0	1	19
		1	1	0	0	1	20
		0	0	1	0	1	21
		1	0	1	0	1	22
		0	1	1	0	1	23
		1	1	1	0	1	24
		0	0	0	1	1	25
		1	0	0	1	1	26
		0	1	0	1	1	27
		1	1	0	1	1	28
		0	0	1	1	1	29
		1	0	1	1	1	30
0	1	1	1	1	31		
1	1	1	1	1	32		
302 - Teach-In, Motion Block Sel. via P. 1228	The current position is saved as the <i>Target Position / Distance</i> 1202 in the motion block selected by the parameter <i>Starting Record Number</i> 1228 .						

Note: Before executing the teach-in function, homing must be completed successfully. Otherwise, error message "F1570 No Homing Done" will be displayed.

The available number of teach-in positions in *Operation Mode* **1221** = 301 depends on the number of digital inputs available for motion block change-over.

Number of digital inputs	Max. number of teach-in positions
1	2
2	4
3	8
4	16
5	32

Note: The teach-in function can be used for saving the target positions. The other values of the motion blocks such as speed, acceleration, etc. are changed via the corresponding parameters.

4.7 Electronic gear

Electronic gears are used in many plants where a synchronous operation, either continuous or for a limited period of time, of several drives is required. The function includes:

- Activation/deactivation of synchronization of several drives at any time during operation.
- Adjustable ratio of different gear factors between master and slave.
- Parameterizable signals for feedback "In Gear".
- Synchronization of slave drive with master drive via system bus or encoder inputs.
- Combination of electronic gear with positioning modes possible

Note: If two encoders (motor encoder and position encoder) are used, the function "Electronic Gear" can only be used via system bus.

Typical applications include:

- Belt conveyors
Example: Several belt conveyors are connected in series mechanically. The material is transferred from one conveyor to the next which conveys it at the same speed. The different motor gears are compensated in the internal calculation in the slave.
- Hoisting applications
Example: A material elevator is driven by 2 motors on the left and right side. For safety reasons (redundancy) and in order to save space and reduce costs, two identical small motors are used instead of one large motor. Synchronous operation prevents tilting of the platform.

4.7.1 Master position source

The following operation modes are available for selecting the source of the signal for positioning in combination with the electronic gear function. Via parameter *Master Position Source* **1122**, the operation mode is selected.

<i>Master Position Source</i> 1122	Function
0 - Off	No source selected.
1 - Encoder 1	The current speed and position of the master drive is taken over from encoder input 1.
2 - Encoder 2 / Resolver	The current speed and position of the master drive is taken over from encoder input 2 or resolver.
11 - RxPDO1.Long1 extrapolated	The current position of the master drive is taken over by the process data channel RxPDO1.Long1 of the system bus. Additionally, the data received are extrapolated, even for slow settings of TxPDO Time of the master. Depending on the application, select a setting of the corresponding TxPDO.Long of the master: <ul style="list-style-type: none"> – "606 – Act. Position (16/16)", mechanical position of master drive. – "620 – motion profile gen.: Ref. Position", reference position of master drive; advantage: improved controller properties

In setting "11 - RxPDO1.Long1 extrapolated" of parameter *Master Position Source 1122* the system bus synchronization must be set to 1 or 10 to ensure a reliable function of *Operation Mode 1180*.

Operation mode 1180	
0	Off ¹⁾
1	RxPDO1 ²⁾
2	RxPDO2 ³⁾
3	RxPDO3 ³⁾
10	SYNC

¹⁾ If the error message "F1453 Systembus-Synchronization not activated" is displayed when the slave drive is started, one of the operation modes 1, 2, 3 or 10 must be selected.

²⁾ Synchronization of processing with data telegram or cyclic sending of SYNC telegram.

³⁾ Not recommended for el. gear because no extrapolation done.

The synchronization of several drives needs high refresh rates to assure optimum results. Set the corresponding time (i.e. *TxPDO1 Time 931*) at the transmit side to a low value. For the usage of the sync-function at the system bus set *SYNC-Time 919* to a low value.

The bus load of the system bus must have sufficient reserves for proper operation.

Note: The system bus is described in the manuals of the extension modules with system bus interface.

Block diagram: electronic gear and phasing function

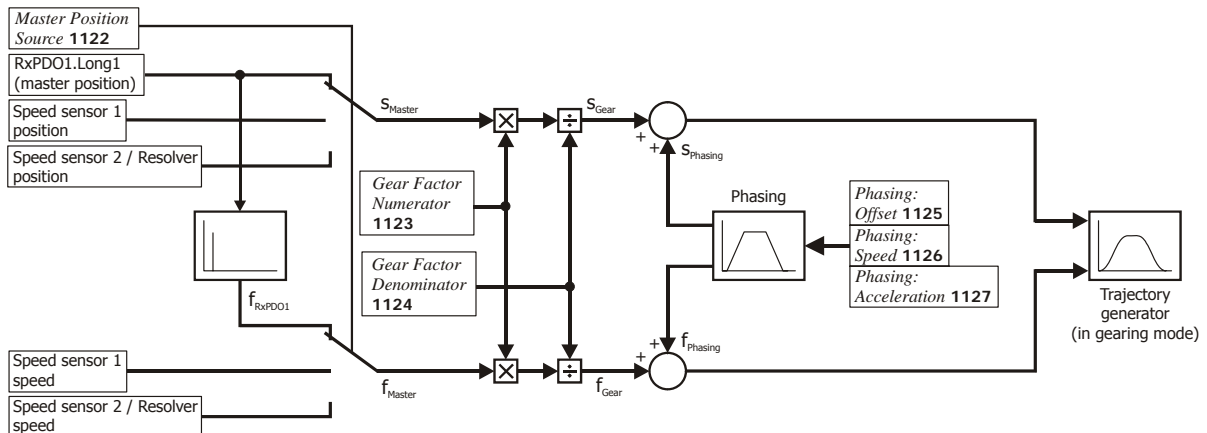

4.7.2 Gear factor

Via parameters *Gear Factor Numerator 1123* and *Gear Factor Denominator 1124*, the gear factor is set permanently at the frequency inverter of the Slave drive.

$$\text{Gear factor} = \frac{\text{Gear Factor Numerator } 1123}{\text{Gear Factor Denominator } 1124}$$

Parameter		Setting		
No.	Description	Min.	Max.	Fact. sett.
1123	Gear Factor Numerator	-32 767	32 767	1
1124	Gear Factor Denominator	1	65 535	1

4.7.3 Resynchronization

Limitation of acceleration when the gear factor is changed is effected via parameter *Resync. on Change of Gear-Factor 1142*. The slave is resynchronized with the master when the gear factor has changed. This function avoids sudden speed changes.

<i>Resync. on Change of Gear Factor 1142</i>	Function
0 - Off	Resynchronization is switched off.
1 - On	The slave is resynchronized with the master frequency when the gear factor has changed. The drive adjusts to the new frequency. The acceleration ramps set in the motion block are considered. If the gear factor changes, signals "57 – In Gear" and "624 – In Gear" are reset. As soon as the new frequency is reached, the signals are set again.

4.7.4 Phasing function

With the phasing function, the slave position is offset from the physical position of the master by the value entered in *Phasing: Offset 1125*.

The function can be executed via a logic signal assigned to parameter *Start Phasing 1128*. After start, *Phasing: Speed 1126* and *Phasing: Acceleration 1127* are used until the slave position is offset from the master position by *Phasing: Offset 1125*.

Parameter		Setting		
No.	Description	Min.	Max.	Fact. sett.
1125	Phasing: Offset	$-(2^{31}-1) \text{ u}$	$2^{31}-1 \text{ u}$	65 536 u
1126	Phasing: Speed ¹⁾	1 u/s	$2^{31}-1 \text{ u/s}$	65 536 u/s
1127	Phasing: Acceleration	1 u/s ²	$2^{31}-1 \text{ u/s}^2$	65 536 u/s ²

¹⁾ is added to master speed

Parameter		Factory setting	
1128	Start Phasing	7 -	Off

Input and output signals of phasing function

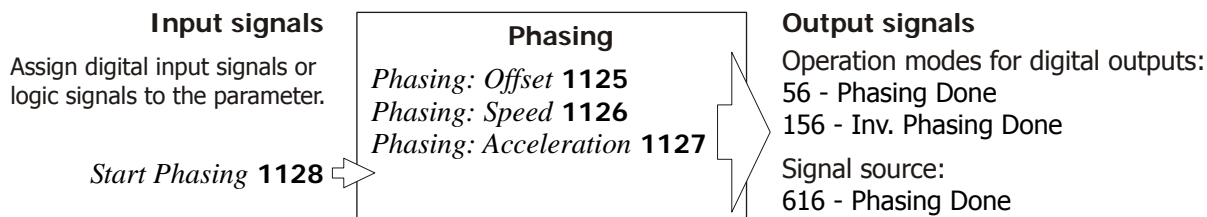

Example of phasing function:

1. Signal "Start Phasing" is set.
 2. Acceleration at "Phasing: Acceleration" to "Phasing: Speed".
 3. After offset by "Phasing: Offset", the digital signal "616 - Phasing Done" is set.
- The signal is available as operation mode "56 - Phasing Done" for digital outputs.

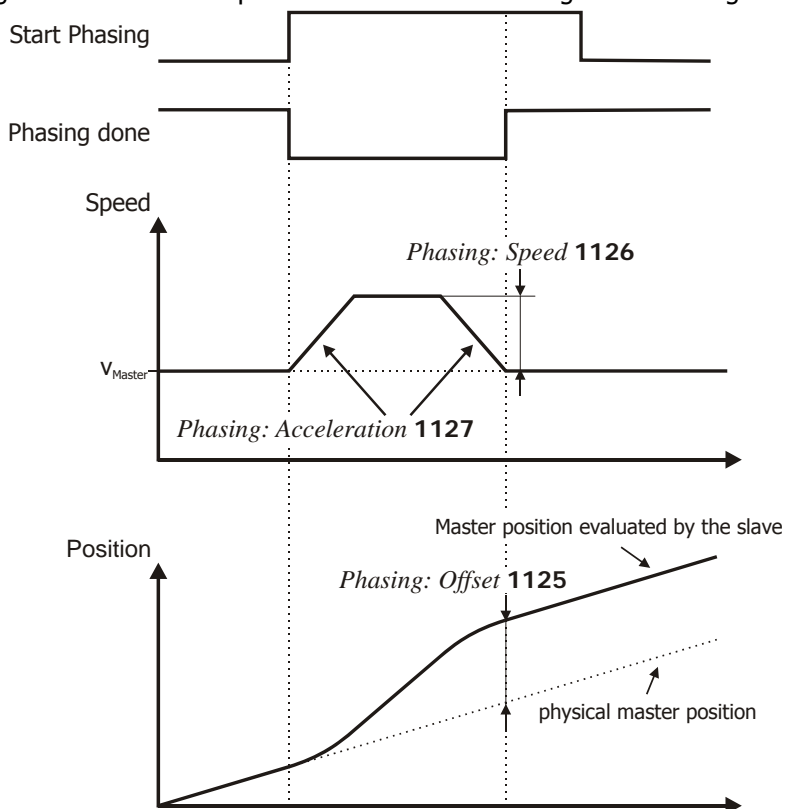

The phasing function can be cancelled by resetting the Start Phasing signal. The current speed is reduced at the value of *Phasing: Acceleration 1127* and signal "56 - Phasing Done" is set.

Example of cancellation of phasing function

1. Signal "Start Phasing" is set
2. Deceleration to master speed
3. Signal "Phasing Done" is set

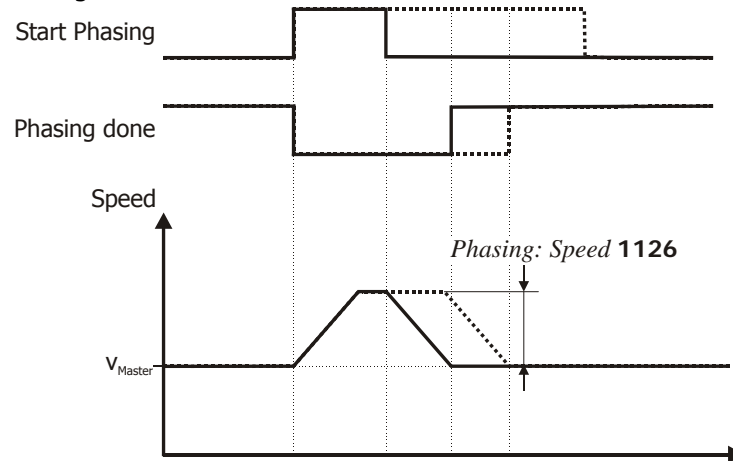

4.8 Monitoring Functions

4.8.1 Travel limits

Bumping into the mechanical stops of a limited travel range can be prevented by:

- Hardware limit switches
- Software limit switches (parameters)

Limit switches can be used in order to protect the machine and to limit the travel range.

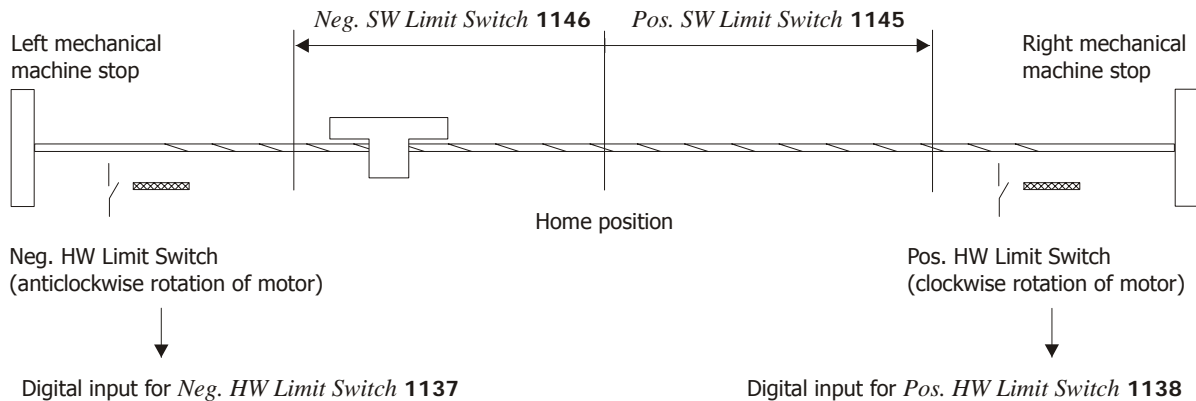

Note: The software limit switches are active only after a successful homing operation.

4.8.2 Hardware limit switches



Warning! The position axis must be provided with hardware limit switches. They prevent bumping into mechanical stops and damaging of the machine.

Hardware limit switches must be arranged mechanically such that, in the case of an error, there is still sufficient distance left for stopping the drive.

If the travel range is limited by hardware limit switches only and if they are evaluated by the frequency inverter, the following must be considered: Changing the parameter settings of the hardware limit switches, deactivation of the fault reaction or setting of the fault reaction to "Warning" may result in the drive not stopping when it reaches the hardware limit switches.

If high values are adjusted for speed and acceleration, and the system has a high mass moment of inertia, it may overrun the limit switches and bump into the mechanical stops of the plant. Do not set excessively high speed and acceleration values in order to avoid damage.

Test hardware limit switches before commissioning:

- Disconnect drive from load to avoid damage.
- Check evaluation of hardware limit switches.
- Check wiring of hardware limit switches: Neg. HW limit switch on negative end of travel range for anticlockwise rotation of motor, pos. HW limit switch on positive end of travel range for clockwise operation of motor.

For each direction of motion, there is one HW limit switch.
The HW limit switches are connected to digital inputs which are assigned to parameters *Neg. HW Limit Switch* **1137** and *Pos. HW Limit Switch* **1138**.

	Parameter	Factory setting	Setting, e.g.
1138	Pos. HW Limit Switch	7 - Off	540 - S4IND inverted (Hardware)
1137	Neg. HW Limit Switch	7 - Off	541 - S5IND inverted (Hardware)

Attention! For the connection of HW limit switches to the inputs S4IND and S5IND check the setting of parameter *Operation Mode* **490** of speed sensor 1. Set parameter *Operation Mode* **490** = „0 - Off“. Also refer to sections 3.4 and 3.5.1.4.

Input terminals for HW limit switches

Factory settings of the parameters

Pos. HW Limit Switch **1138** = "7 - Off"
Neg. HW Limit Switch **1137** = "7 - Off"

Settings

Pos. HW Limit Switch **1138** =
"540 - S4IND inverted (Hardware)"
Neg. HW Limit Switch **1137** =
"541 - S5IND inverted (Hardware)"

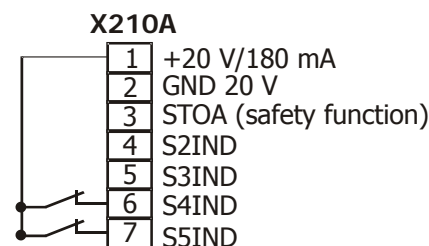

Note: For wire-break monitoring, the inverted signals of the parameters of the HW limit switches can be evaluated, e.g. *Pos. HW Limit Switch* **1138** = "540 - S4IND inverted (Hardware)". In this case, the limit switches must be designed as break contacts.

The limit switches are monitored, considering the direction of rotation. An error is signaled if the position of the limit switches does not correspond to the direction of rotation of the motor, i.e. if limit switches are wired incorrectly. The positive HW limit switch must be in positive direction for Motor Clockwise. The negative HW limit switch must be in negative direction for Motor Anticlockwise.

The limit switch inputs evaluate static signals (no signal edges). Pulse switches are not evaluated as hardware limit switches.

Note: Possibly overrunning of hardware limit switches is not monitored. This can happen if the signal time of the limit switch is too short to be recognized by the frequency inverter.

Example: If the negative limit switch is reached, the limit switch signal triggers the selected fault reaction (parameter 1143). However, if the limit switch is overrun and the limit switch signal is no longer present, the axis continues to move in negative direction if the controller release and start positioning signals are still present.

Limit switch cannot be overrun:

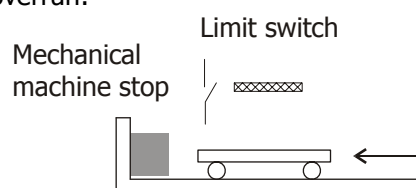

Input signals and error messages /warnings of hardware limit switches:

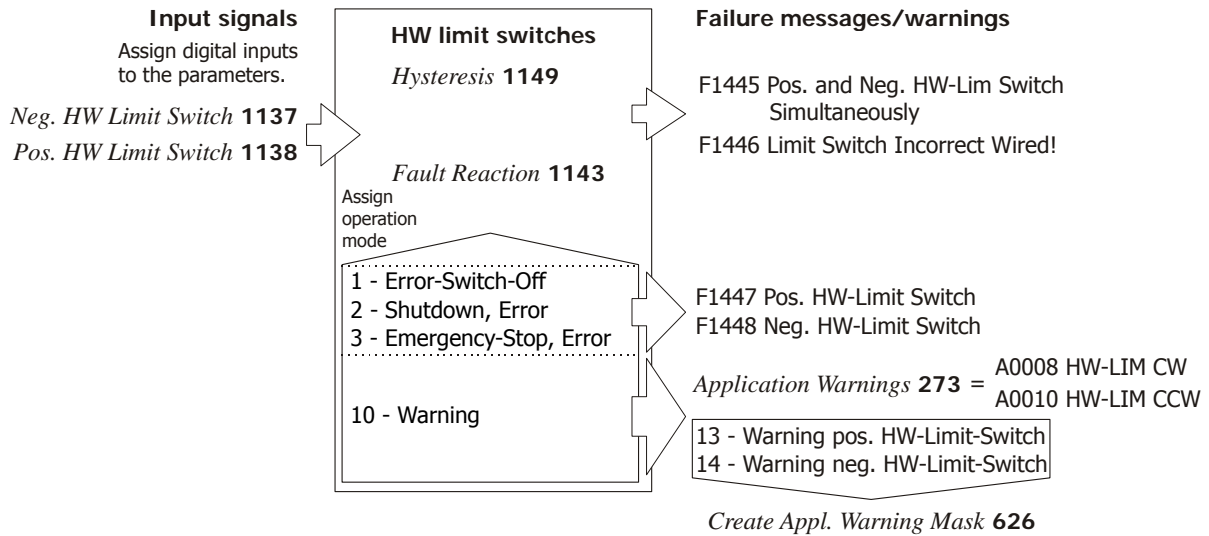

The following digital inputs and operation modes can be assigned to the parameters *Pos. HW Limit Switch 1138* and *Neg. HW Limit Switch 1137*.

Available settings for <i>Pos. HW Limit Switch 1138</i> , <i>Neg. HW Limit Switch 1137</i>	
6 - TRUE	532 - EM-S1IND (Hardware) ^{1) 2)}
7 - FALSE	533 - EM-S2IND (Hardware) ¹⁾
284 - STOA inverted	534 - EM-S3IND (Hardware) ¹⁾
285 - STOB inverted	538 - S2IND inverted (Hardware)
292 - STOA	539 - S3IND inverted (Hardware)
293 - STOB	540 - S4IND inverted (Hardware)
526 - S2IND (Hardware)	541 - S5IND inverted (Hardware)
527 - S3IND (Hardware)	542 - S6IND inverted (Hardware)
528 - S4IND (Hardware)	543 - MFI1D inverted (Hardware)
529 - S5IND (Hardware)	544 - EM-S1IND inverted (Hardware) ¹⁾
530 - S6IND (Hardware)	545 - EM-S2IND inverted (Hardware) ¹⁾
531 - MFI1D (Hardware)	546 - EM-S3IND inverted (Hardware) ¹⁾

¹⁾ Requires an expansion module.

²⁾ If an expansion module with digital port (switch-selectable digital input/output) is installed *Operation Mode 558* must be set to "0 - Input".

³⁾ If MFI1D is used as hardware limit switch input take into account that the sampling rate of this input is lower than the sampling rate of the other digital inputs.

4.8.2.1 Hysteresis for hardware limit switch

Via parameter *Hysteresis 1149*, the switching hysteresis of a limit switch (e.g. proximity switch) can be considered. In addition, the hysteresis prevents non-defined switching when the axis has stopped at a limit switch position.

The drive can be enabled if the distance between the axis and the hardware limit switch exceeds the value of parameter *Hysteresis 1149*.

Parameter		Setting		
No.	Description	Min.	Max.	Fact. sett.
1149	Hysteresis	0 u	$2^{31}-1$ u	182 u

Example:

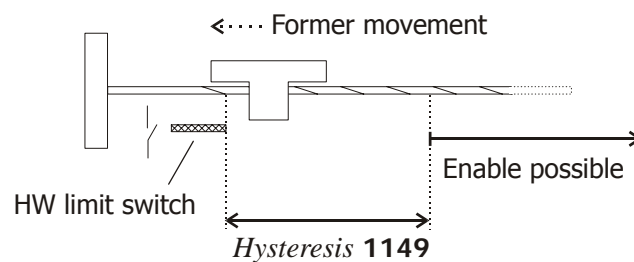

The HW limit switch is activated. The drive can only be enabled after the axis has been travelled the distance of *Hysteresis 1149* opposite to the former movement.

JOG-Mode can be used to move away from a HW limit switch. Refer to section 4.5 and 4.8.2.3.

4.8.2.2 Fault reaction

Via parameter *Fault Reaction 1143*, you can define the behavior of the drive when the hardware limit switch is reached.

<i>Fault Reaction 1143</i>	Function
0 - Disabled	No evaluation of hardware limit switches.
1 - Error-Switch-Off	Factory setting. The drive is stopped and error message "F1447 Pos. HW Limit Switch" or "F1448 Neg. HW Limit Switch" is output.
2 - Shutdown, Error	The drive is stopped at the current deceleration ramp ¹⁾ and error message "F1447 Pos. HW Limit Switch" or "F1448 Neg. HW Limit Switch" is output.
3 - Emergency-Stop, Error	The drive is stopped at the current emergency ramp ²⁾ and error message "F1447 Pos. HW Limit Switch" or "F1448 Neg. HW Limit Switch" is output.
10 - Warning	Via parameter <i>Application Warnings 273</i> , warning message "A 0008 HW-LIM CW" is output when the positive HW limit switch is reached, "A 0010 HW-LIM CCW" is output when the negative HW limit switch is reached. For parameter <i>Create Appl. Warning Mask 626</i> , "13 - Warning pos. HW-Limit-Switch" and "14 - Warning neg. HW-Limit-Switch" are available.

¹⁾ Deceleration ramp:

In JOG mode, the drive is stopped based on the values for parameters *Deceleration 1177*, *Ramp Fall Time 1178*.

When motion blocks are processed, the drive is stopped based on the values for *Deceleration 1206* and *Ramp Fall Time 1207*.

²⁾ Emergency ramp: The drive is stopped based on the value for parameter *Emergency ramp 1179*.

Warnings and error messages of hardware limit switches

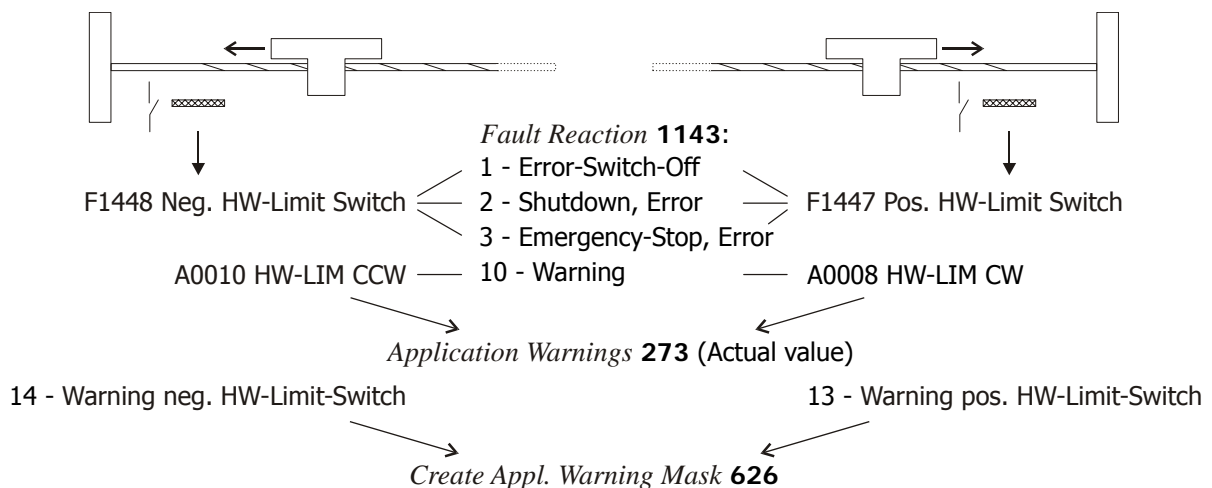

Hardware limit switches can also be used for homing. In this case, the hardware limit switches are not evaluated by parameter *Fault Reaction* **1143** during homing.



Warning! If evaluation of hardware limit switches is off, external control measures must be taken to ensure that in dangerous situations, e.g. hardware limit switch overrun, safety device open, danger of loads falling down, the drive is switched off immediately and a mechanical brake is triggered, if necessary. Evaluation of the hardware limit switches does not perform any safety functions and does not meet the requirements of any standardized safety category.

4.8.2.3 Move away from HW limit switches

If an axis is at a hardware limit switch, the drive is disabled for the direction from where the limit switch was approached. In this case:

- Acknowledge error and move in opposite direction in JOG mode (refer to section 4.5) or
- Acknowledge error and start positioning in opposite direction

If you try to position in the former direction, error message "F1451 Clockwise Operation Locked" or "F1452 Anticlockwise Operation Locked" will be displayed.

4.8.3 Software limit switches

For limitation of the travel range or protection of the machine, parameters *Positive SW Limit Switch* **1145** and *Negative SW Limit Switch* **1146** can be set. Travel commands will be executed within this travel range only.

The parameters of the SW limit switches should be set such that the HW limit switches and SW limit switches are not reached during operation.

The SW limit switches are related to the point of reference.

The SW limit switches are ready for operation if:

- a homing operation was completed successfully and
- one of the following operation modes is selected for parameter *Fault Reaction* **1144**: "1 – Error Switch-Off", "2 – Shutdown, Error", "3 – Emergency-Stop, Error", "10 – Warning".

Parameter		Setting		
No.	Description	Min.	Max.	Fact. sett.
1145	Pos. SW Limit Switch	$-(2^{31}-1) u$	$2^{31}-1 u$	65 536 u
1146	Neg. SW Limit Switch	$-(2^{31}-1) u$	$2^{31}-1 u$	-65 536 u

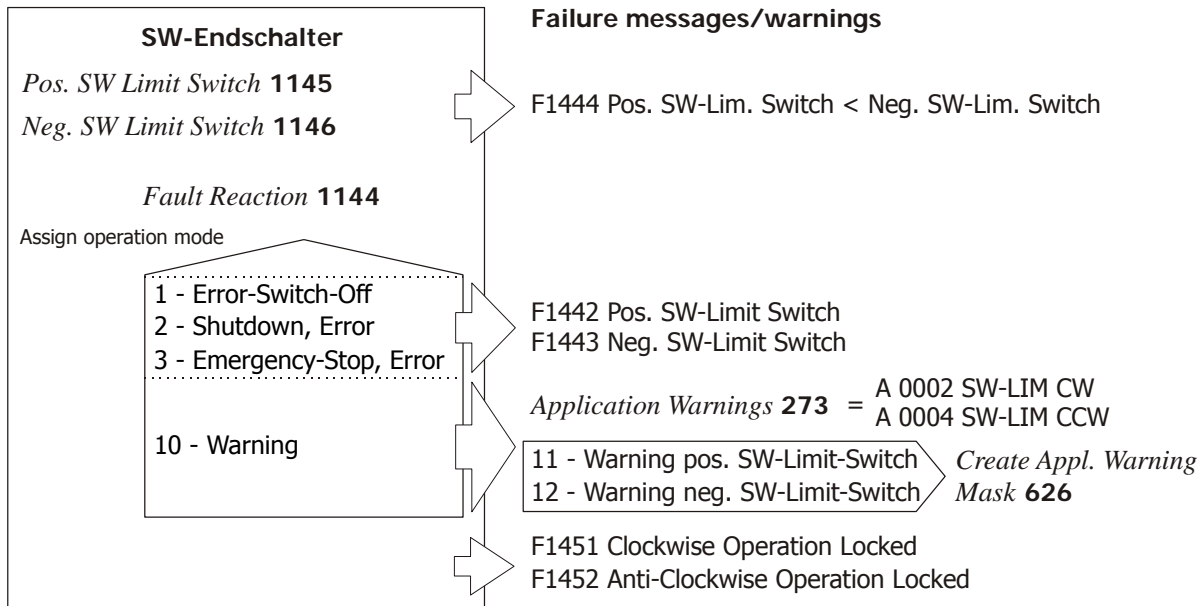
Error messages/warnings of software limit switches:

Via parameter *Fault Reaction 1144*, you can define the behavior of the drive when the software limit switch is reached.

<i>Fault Reaction 1144</i>	Function
0 - Disabled	Factory setting. No evaluation of software limit switches.
1 - Error Switch-Off	The drive is stopped and error message "F1442 Pos. SW Limit Switch" or "F1443 Neg. SW Limit Switch" is output.
2 - Shutdown, error	The drive is stopped at the current deceleration ramp ¹⁾ and error message "F1442 Pos. SW Limit Switch" or "F1443 Neg. SW Limit Switch" is output.
3 - Emergency-Stop, Error	The drive is stopped at the current emergency ramp ²⁾ and error message "F1442 Pos. SW Limit Switch" or "F1443 Neg. SW Limit Switch" is output.
10 - Warning	Via parameter <i>Application Warnings 273</i> , warning message "A 0002 LW-LIM CW" is output when the positive SW limit switch is reached, "A 0010 SW-LIM CCW" is output when the negative SW limit switch is reached. For parameter <i>Create Appl. Warning Mask 626</i> , "11 - Warning pos. SW-Limit-Switch" and "12 - Warning neg. SW-Limit-Switch" are available.

¹⁾ Deceleration ramp:

In JOG mode, the drive is stopped based on the values for parameters *Deceleration 1177*, *Ramp Fall Time 1178*.

When motion blocks are processed, the drive is stopped based on the values for *Deceleration 1206* and *Ramp Fall Time 1207*.

²⁾ Emergency ramp: The drive is stopped based on the value for parameter *Emergency ramp 1179*.

Warnings and error messages of software limit switches

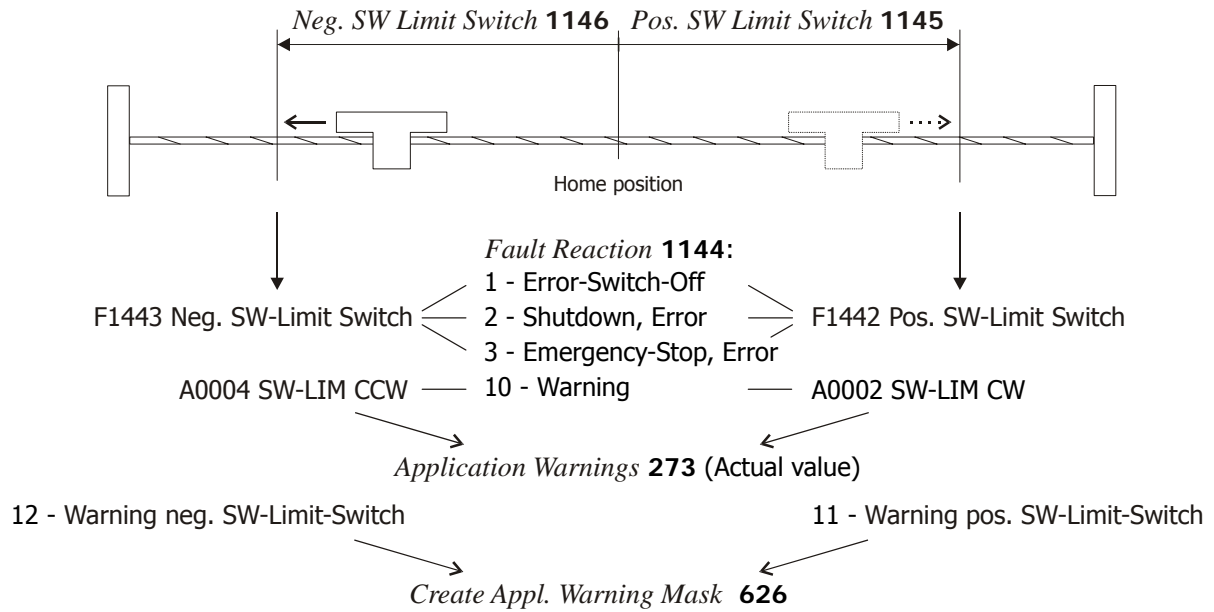

Note: Limit switches are assigned as follows: Pos. SW limit switch for clockwise operation, neg. SW limit switch for anticlockwise operation.

When software limit switches are evaluated, the behavior of the drive depends on the *Motion Mode 1208* and *Fault Reaction 1144*:

<i>Motion Mode 1208</i>	<i>Behavior</i>
0 - absolute, 1 - relative	If the <i>Target Position/Distance 1202</i> is outside of the travel range defined by parameters <i>Positive SW Limit Switch 1145</i> and <i>Negative SW Limit Switch 1146</i> , the motion block will not be started. The drive reacts as defined in parameter <i>Fault Reaction 1144</i> .
2 - Touch probe 3 - Touch probe	If the SW limit switches are overrun before the touch-probe signal was received, the drive reacts as defined in parameter <i>Fault Reaction 1144</i> . If the current <i>Target Position/Distance 1202</i> is outside of the defined travel range when the touch-probe signal has been received, the target position will not be approached. The drive reacts as defined in parameter <i>Fault Reaction 1144</i> .
4 - Velocity, 10 ... 24 - gearing JOG function	The drive moves to the position of a SW limit switch. Then, the drive reacts as defined in parameter <i>Fault Reaction 1144</i> .

4.8.3.1 Move away from SW limit switches

The axis can be moved to the defined travel range again:

- Acknowledge error and move in opposite direction in JOG mode or
- Acknowledge error and start positioning in opposite direction

Error "F1444 Pos. SW-Lim. Switch < Neg. SW-Lim. Switch" is displayed if parameters *Positive SW Limit Switch* **1145** and *Negative SW Limit Switch* **1146** are set such that the positive SW switch is to the left of the negative SW switch. The value of the positive SW switch must be greater than the value of the negative SW switch.

If the axis is at the position of a software limit switch, the corresponding direction of rotation of the drive is disabled. If you try to move in this direction, error message "F1451 Clockwise Operation Locked" or "F1452 Anticlockwise Operation Locked" will be displayed.

4.8.4 Target window

The target window monitors the current position after completion of a positioning operation. A positioning operation is complete as soon as the current position is in the target window. Via parameter *Target Window 1165*, you can define as from which distance from the target position the signal "60 – Target Position Reached" is set. This setting is valid both for the positive and negative direction.

If the parameter value is set to 0, the operation will be complete as soon as the target position is reached.

Via parameter *Target Window Time 1166*, you can define how long the axis must be in the target window before "60 – Target Position Reached" is signaled.

Parameter		Setting		
No.	Description	Min.	Max.	Fact. sett.
1165	Target Window	0 u	2^{20} u	182 u
1166	Target Window Time	1 ms	65 535 ms	1 ms

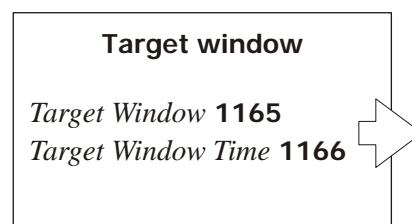

Output signals

Operation modes for digital outputs:

60 - Target Position Reached

160 - Inv. Arrived at desired Position

Signal source:

282 - Target Position Reached

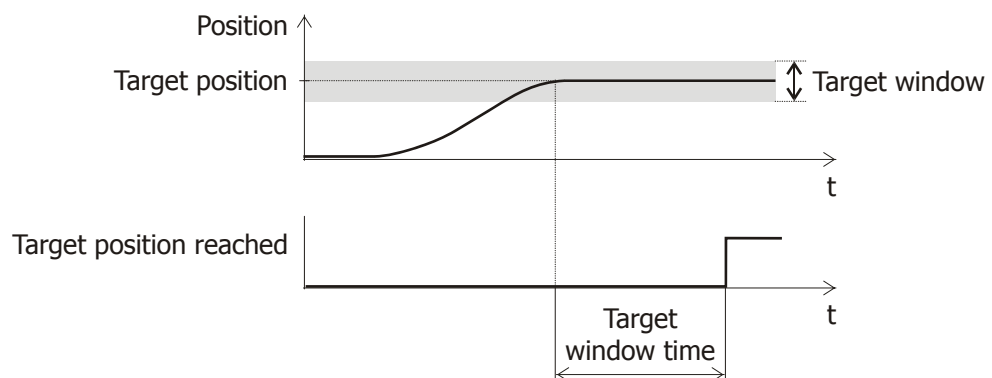

Note: The size of the target window affects the automatic sequence of motion blocks because the positioning operation requires a higher precision in the case of a small target window (small tolerance). The following motion block is started when the target window is reached.

4.8.5 Contouring error supervision

Contouring errors may occur, for example, if the acceleration and deceleration ramps are not adjusted to the moment of inertia of the load and the drive cannot follow the specified reference values. With the contouring error threshold, you can define a maximum deviation between the current position and the required position. If this limit is exceeded for a user-defined time, the drive will respond as defined in parameter *Fault Reaction 1120*.

<i>Fault Reaction 1120</i>	Function
0 - Disabled	Factory setting. No evaluation of contouring error threshold.
1 - Error-Switch-Off	The drive is switched off and error message "F0404 Control Deviation Position Controller" is output, if the <i>Error Threshold 1106</i> was exceeded by the time defined in <i>Contouring Error Time 1119</i> .
2 - Shutdown, Error	The drive is stopped at the current deceleration ramp ¹⁾ and error message "F0404 Control Deviation Position Controller" is output, if the <i>Error Threshold 1106</i> was exceeded by the time defined in <i>Contouring Error Time 1119</i> .
3 - Emergency-Stop, Error	The drive is stopped at the current emergency ramp ²⁾ and error message "F0404 Control Deviation Position Controller" is output, if the <i>Error Threshold 1106</i> was exceeded by the time defined in <i>Contouring Error Time 1119</i> .

¹⁾ Deceleration ramp:

In JOG mode, the drive is stopped based on the values for parameters *Deceleration 1177*, *Ramp Fall Time 1178*.

When motion blocks are processed, the drive is stopped based on the values for *Deceleration 1206* and *Ramp Fall Time 1207*.

²⁾ Emergency ramp: The drive is stopped based on the value for parameter *Emergency ramp 1179*.

If the range defined by parameter *Warning Threshold 1105* is left, the following is performed:

- Signal "604 – Warning Position Controller" is set.
- The warning is available via "61 - Warning Deviation of Position" and "161 - inv. Warning Deviation of Position" for digital outputs.
- Parameter *Application Warnings 273* reads "A0020 CONT".

If the range defined by parameter *Error Threshold 1106* is left, the drive responds as defined in *Fault Reaction 1120*.

Via parameter *Contouring Error Time 1119*, you can define how long the *Error Threshold 1106* may be exceeded before the *Fault Reaction 1120* is triggered.

Parameter		Setting		
No.	Description	Min.	Max.	Fact. sett.
1105	Warning Threshold	0 u	2 ³¹ -1 u	32 768 u
1106	Error Threshold	0 u	2 ³¹ -1 u	65 536 u
1119	Contouring Error Time	0 u	65 535 ms	10 ms

Contouring error supervision output signals

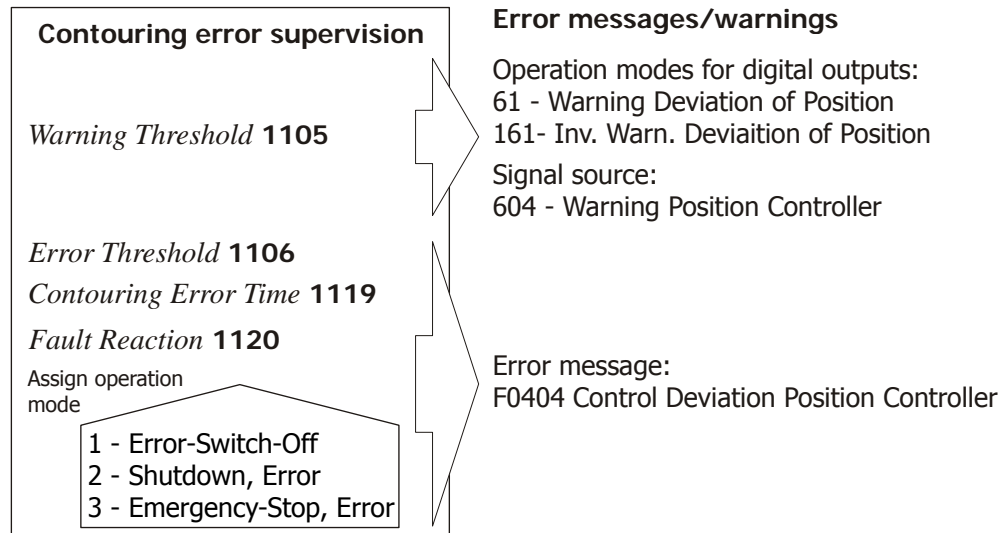

Note: The contouring error threshold has no influence on the positioning accuracy but defines how exactly the travel distance must be kept so that no error is signaled.
 Very low contouring error values may cause frequent error messages.

Parameter *Act. Contouring Error 1109* contains the current contouring error value.

The peak contouring error value can be monitored via parameter *Peak Value Contouring Error 1121* in the actual value memory.

With parametersetting *Reset Memory 237* = "18 - Peak Value Contouring Error", you can reset the saved value on the optional control unit KP500 or via a communication interface.

By reducing the acceleration and deceleration values step by step, triggering of the contouring error can be avoided. The reduction of these values, however, also changes the motion profile so that it may no longer meet the requirements of the application. In this case, the mechanical design and the selected drive power must be checked.

4.8.6 Warning mask Application

The logic signals of monitoring and control functions can be selected via parameter *Create Warning Mask 536*. For the available options, refer to the operating instructions. The logic signals of different positioning monitoring functions can be selected via parameter *Create Appl. Warning Mask 626*. As soon as limit switches are reached or contouring error thresholds are exceeded, a warning can be issued. The warnings refer to the parameter values set in error/warning behavior in configurations x40. Depending on the application, any number of warnings can be configured. The warnings are selected via parameter *Create Appl. Warning Mask 626*:

<i>Create warning mask application 626</i>	Function
0 - No change	The configured warning mask is not changed.
2 - Activate all Warnings	The warnings reports stated are linked in the warning mask.
10 - Warning V-Belt	Warning message of V-belt monitoring according to <i>Operation Mode 581</i> .
11 - Warning pos. SW limit switch	Warning message indicating that the positive SW limit switch has been reached.
12 - Warning neg. SW limit switch	Warning message indicating that the negative SW limit switch has been reached.
13 - Warning pos. HW limit switch	Warning message indicating that the positive HW limit switch has been reached.
14 - Warning neg. HW limit switch	Warning message indicating that the negative HW limit switch has been reached.
15 - Warning position controller	Warning message, indicating that the contouring error monitoring range adjusted with parameter <i>Warning Threshold 1105</i> has been left.
102 - Deactivate All Warnings	All warnings are deactivated.
110 - Deactivate Warning V-Belt	No warning message of V-belt monitoring.
111 - Deactivate warning pos. SW limit switch	No warning when positive SW limit switch is reached.
112 - Deactivate warning neg. SW limit switch	No warning when negative SW limit switch is reached.
113 - Deactivate warning pos. HW limit switch	No warning when positive HW limit switch is reached.
114 - Deactivate warning neg. HW limit switch	No warning when negative HW limit switch is reached.
115 - Deactivate warning position controller	No warning message when contouring error monitoring range adjusted with parameter <i>Warning Threshold 1105</i> has been left.

Warning messages affecting the positioning functions can be displayed via parameter *Application Warnings 273* as actual values.

In the error environment, *Application Warning Status 367* indicates the current warnings of the positioning functions.

The current warning mask can be read via parameter *Actual Appl. Warning Mask 627*. The operation modes of parameter *Create Appl. Warning Mask 626* are encoded in *Actual Appl. Warning Mask 627*. If several warnings are combined, the code can be calculated from the hexadecimal addition of the individual warnings and the corresponding code.

Warning code		<i>Create Warning Mask Application 626</i>
A	FFFF -	2 - Activate all Warnings
A	0002 SW-LIM CW	11 - Warning pos. SW limit switch
A	0004 SW-LIM CCW	12 - Warning neg. SW limit switch
A	0008 HW-LIM CW	13 - Warning pos. HW limit switch
A	0010 HW-LIM CCW	14 - Warning neg. HW limit switch
A	0020 CONT	15 - Warning position controller

Example:

Warning codes A0002 SW-LIM CW + A0004 SW-LIM CCW
= Warning code A0006 SW-LIM CW SW-LIM CCW

The individual warning messages and the configured warning mask are available as operation modes for the digital outputs:

Digital signal	Function
26 - Application Warning	All warnings application are deactivated.
27 - Warning Mask, Application	All warnings of Warning Mask, Application are activated.
28 - Warning, gen. + Warning, Application	All warnings and application warnings are deactivated.
29 - Warn. Mask, gen. + Warn. Mask, Appl.	All warnings of warning mask and all warnings of application warning mask are activated.
126 - Inv. Warning Application	Operation mode 26 inverted
127 - Inv. Warning Mask Application	Operation mode 27 inverted
128 - Inv. Warning, gen. + Warning, Application	Operation mode 28 inverted
129 - Inv. Warn. Mask, gen + Warn.	Operation mode 29 inverted

Additionally, logic signals "215 – Application Warning Mask" and "216 – Application Warning" can be used as sources for logic functions.

If an application warning is present, "A8000 Warn2" is displayed additionally via parameter *Warnings 269*.

4.9 Speed Override

The positioning function uses the parameterized speeds of the individual motion blocks.

Alternatively, the positioning speed can be defined via an external reference value source. For this purpose, the *Speed Override 1236* function is enabled. The set values can be changed during operation dynamically, e.g. by a potentiometer on an analog input. The speed override function does not affect the ramps set for acceleration and deceleration. The function can be used, for example, for commissioning, maintenance or in setup mode.

The signal source for adjusting the speed (e.g. analog multi-function input or fixed percentage) is done via parameter *Reference Value Source 476*.

<i>Speed Override 1236</i>	Function
0 - Off	Factory setting. Speed override disabled. Motion blocks are processed at parameterized speeds.
1 - On	Speed override enabled. The speeds in the motion blocks are set via the selected signal source.

The function does not change the speed in settings 10 to 24 (gearing) for parameter *Motion Mode 1208*. The master speed is still applied. The function has to be activated on the master drive.

Note: The travel speed is limited by the *Maximum frequency 419*. The range (limits for change of travel speed) is defined by *Min. Reference Percentage 518* and *Max. Reference Percentage 519*.

Example: The travel speed is controlled from 0 ... 100% (0 ... 10 V) via a reference value potentiometer on multifunction input MFI1A. The percentages refer to the speed values set in the motion blocks.

- Power supply for reference value potentiometer via terminal X210B.5, ground to terminal X210B.7
- Reference value from potentiometer via multifunction input MFI1A, terminal X210B.6
- Multifunction input 1: Parameter *Operation mode 452* = "1 - Voltage Input"
- Reference value via reference value channel: Parameter *Reference Percentage Source 476* = "1 - Abs. Analog Value MFI1A"
- Parameter *Minimum Reference Percentage 518* = 0.00% (factory setting)
- Parameter *Maximum Reference Percentage 519* = 100.00% (factory setting)
- Parameter *Speed Override 1236* = "1 - On"

Actual value parameter *Reference Percentage 229* shows the specified travel speed percentage.

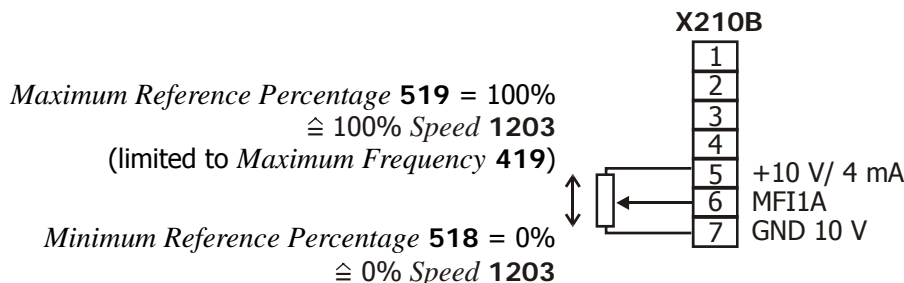

4.10 Position Comparator

The position comparator compares the current position and the specified positions. It checks if the actual position is within the specified range (defined by on and off positions). Via the comparator, logic functions can be controlled or activated, depending on the current position value.

The following signals are set if the current value is in the range between the *On-Position 1243* and the *Off-Position 1244*:

- "58 – Position Comparator" and "158 - Inv. Position Comparator" for digital outputs
- "876 – Position Comparator Out" and "877 - Position Comparator Out inverted" for logic functions

Parameter *Hysteresis 1245* prevents non-defined switching states when the system has stopped exactly at a switching position. In this case, the output is reset if the current position is smaller than the "on position minus hysteresis" or greater than the "off position plus hysteresis".

Actual position	Signal source	
	58 ¹⁾	158 ²⁾
Actual position < On-position - hysteresis	0	1
On-Position - Hysteresis < Actual position < On-position	last value	
On-Position < Actual position < Off-position	1	0
Off-Position < Actual position < Off-position + hysteresis	last value	
Off-Position + Hysteresis < Actual position	0	1

¹⁾ 58 – Position Comparator

²⁾ 158 – Inv. Position Comparator

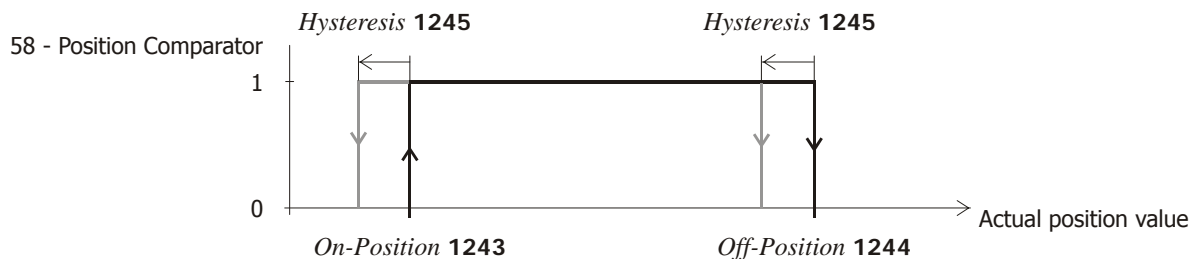

Parameter		Setting		
No.	Description	Min.	Max.	Fact. sett.
1243	On-Position	$-2^{31} u$	$2^{31}-1 u$	0 u
1244	Off-Position	$-2^{31} u$	$2^{31}-1 u$	65 536 u
1245	Hysteresis	0 u	$2^{31}-1 u$	182 u

The position comparator is active only if *On-Position 1243* < *Off-Position 1244*. If *On-Position 1243* \geq *Off-Position 1244*, the position comparator will continuously signal "0".

Via parameter *Operation Mode 1242*, you can define the source for the actual position to be processed by the comparator.

<i>Operation mode 1242</i>	Function
9 - Off	Comparator is switched off.
606 - Actual position	Current position value is processed by comparator.
631 - Sensorless Act. Position	Current position is processed by comparator (for <i>Configuration 30 = 440</i> only)
708 - RxPDO1 Long1 ¹⁾	Actual position received via system bus is processed by comparator.
709 - RxPDO1 Long2 ¹⁾	
718 - RxPDO2 Long1 ¹⁾	
719 - RxPDO2 Long2 ¹⁾	
728 - RxPDO3 Long1 ¹⁾	
729 - RxPDO3 Long2 ¹⁾	

¹⁾ Set corresponding TxPDO Long to "606 – Act. Position".

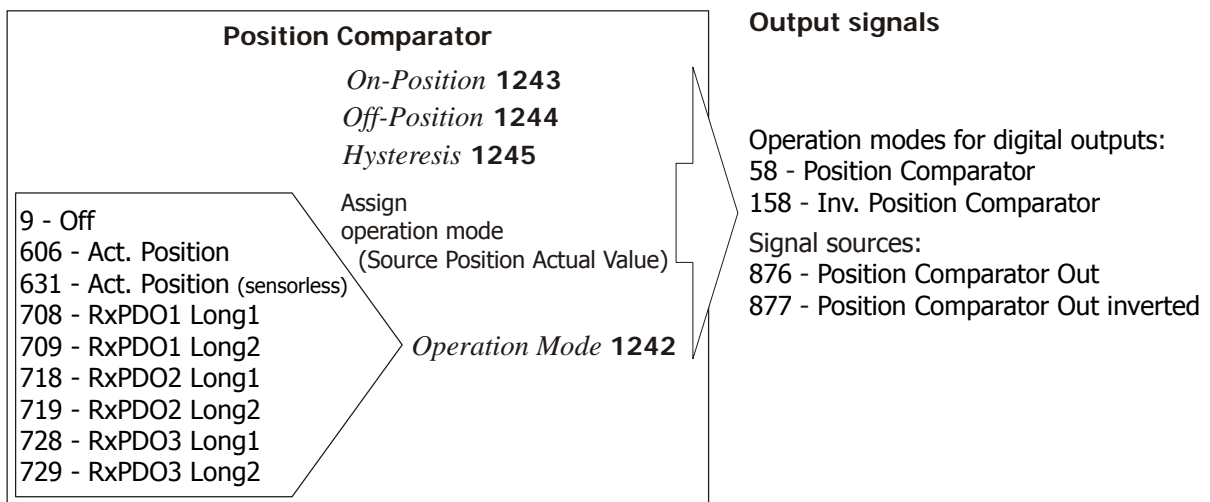

4.11 Rotary Table Application

A rotary table is a round axis with unlimited travel range. No limit switch required.

Unlimited travel ranges.



Via parameter *Operation Mode 1240*, the type of motion to the target position is defined. The direction of rotation and way optimization (shortest way) can be specified.

<i>Operation mode 1240</i>	Function
0 - Off	Round table positioning switched off.
1 - On	Round table positioning switched on. Direction of rotation depends on parameterized target position. Motion is always performed such that 0° will not be passed. Maximum travel range is always smaller than one rotation.
2 - On / Optimized (shortest way)	Shortest way to target position is taken. Relative motions are not optimized; motion blocks must be configured accordingly.
3 - On / Clockwise Rotation	Motion is performed in clockwise (positive) direction (absolute positioning). Negative direction is disabled for absolute positioning.
4 - On / Anticlockwise Rotation	Motion is performed in anticlockwise (negative) direction (absolute positioning). Positive direction is disabled for absolute positioning.

Note: Settings of parameter *Operation Mode 1240* only affect the direction of rotation in the case of absolute positioning operations (parameter *Motion Mode 1208*). Relative positioning operations are not optimized; direction of rotation depends on the settings of parameter *Target Position/Distance 1202* in the motion blocks.

Parameter *Units per Revolution 1241* must be set to the units per revolution. This setting represents the distance covered per revolution.

Parameter		Setting		
No.	Description	Min.	Max.	Fact. sett.
1241	Units Per Revolution	1 u	$2^{31}-1$ u	65 536 u

Note: The reference system must be set up via parameters *Feed Constant 1115*, *Gear Box: Driving shaft revolutions 1116* and *Gear Box: Motor shaft revolutions 1117* (Chapter "Reference system"). Use exact gear transmission factors. The exact gear transmission factor can be calculated from the number of teeth of the individual gearwheels. Do not use rounded values, because this may result in a drift (deviation between the actual position and the required position).

Example: Definition of units as degrees ($^{\circ}$), setup of reference system (*Feed Constant 1115*),

Feed Constant = 3600 for resolution of 0.1° ; revolution distance = 3600 u

Note: In order to limit the travel range of a rotary table, it can be configured as a linear axis. Linear movements can be effected via a round axis, e.g. in the case of a belt conveyor.

Examples for settings of parameter *Operation Mode 1240*:

Example: Operation Mode "1 - On", for absolute and relative positioning

	Current position	Target position	Direction of rotation
Example 1	45°	315°	clockwise (positive); target position > act. position
Example 2	315°	45°	anticlockwise (negative); target position < act. position

Example 1

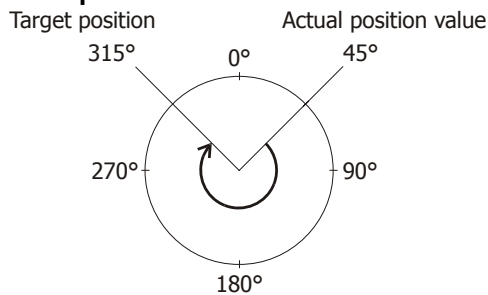

Example 2

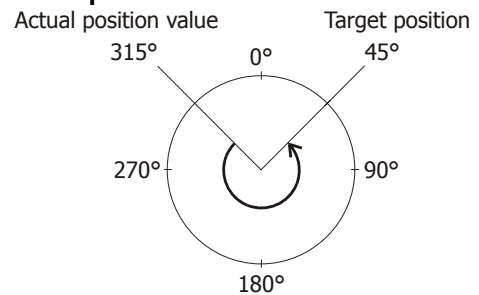

Direction of rotation depends on values for target position in motion blocks.
Angle 0° is not passed.

Example: Operation Mode "2 – On /Optimized (shortest way)" compared to Operation Mode "3 – On /Clockwise Rotation" (not optimized)

	Current position	Target position	Direction of rotation
Operation mode 2	45°	315°	anticlockwise (negative); optimized
Operation mode 3	45°	315°	clockwise (positive)

Operation mode 2

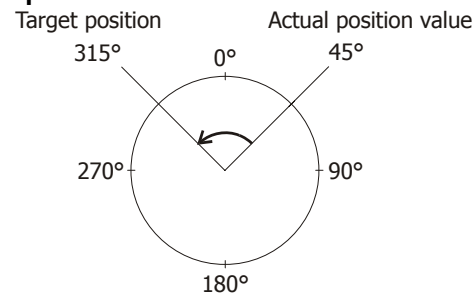

Direction is optimized.

Operation mode 3

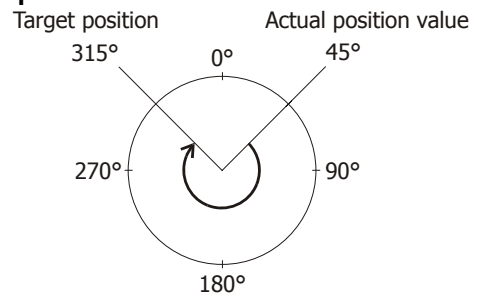

Direction of rotation is defined by operation mode.

**Example: Operation modes "3 – On /Clockwise Rotation" and
4 – "On / Anticlockwise Rotation"**

	Current position	Target position	Direction of rotation
Operation mode 3	45°	315°	clockwise (positive)
Operation mode 4	45°	315°	anticlockwise (negative)

Operation mode 3

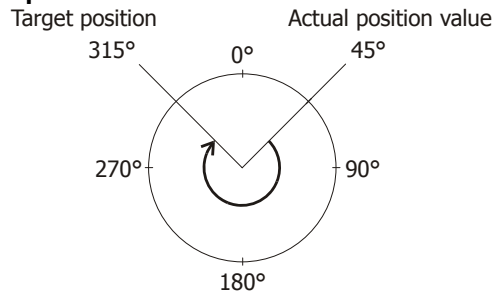

Operation mode 4

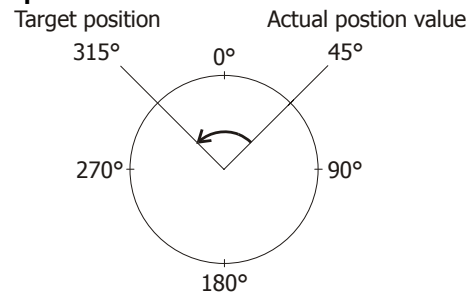

Direction of rotation is defined by operation mode.

4.12 Position Controller

The position controller evaluates the positioning operation (target/actual position) and tries to control the drive such that it comes as close as possible to the specifications. For this purpose, an additional frequency is calculated for compensation of position deviations. By setting the corresponding parameter, this frequency can be limited. The parameter settings of the position controller determine how quick and to what extent position deviations are to be compensated.

Via parameter *Time Constant* **1104**, you can define the maximum time in which the position deviation is to be compensated.

Via parameter *Limitation* **1118**, you can define to which value the speed is limited for compensation of the position deviation.

Parameter		Setting		
No.	Description	Min.	Max.	Fact. sett.
1104	Time Constant	0.00 ms	300.00 ms	10.00 ms ¹⁾ 100.00 ms ²⁾
1118	Limitation	0 u/s	2 ³¹ -1 u/s	327 680 u/s

¹⁾ Factory setting for selection *Configuration* **30** = 240 or 540

²⁾ Factory setting for selection *Configuration* **30** = 440

Example:

Position deviates by 1 motor shaft revolution, time constant is set to 1 ms. The position controller will increase the motor frequency by 1000 Hz in order to compensate the position deviation. Parameter *Limitation* **1118** must be set accordingly.

Controller block diagram

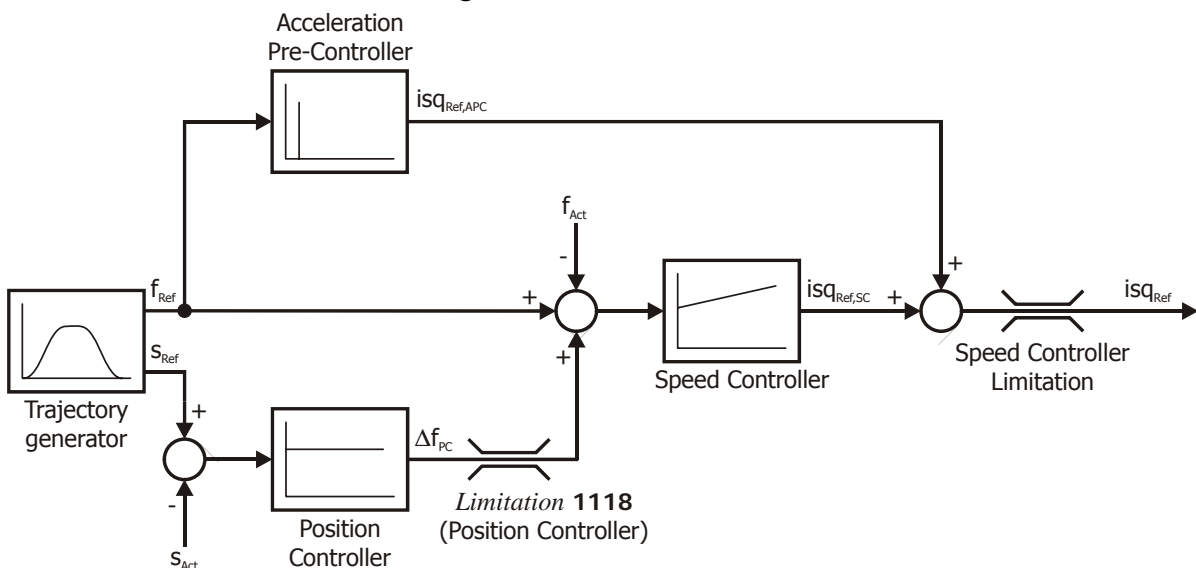

In order to avoid oscillations of the drive while it is at standstill, amplification is reduced to 50 % of the parameterized value for small position deviations

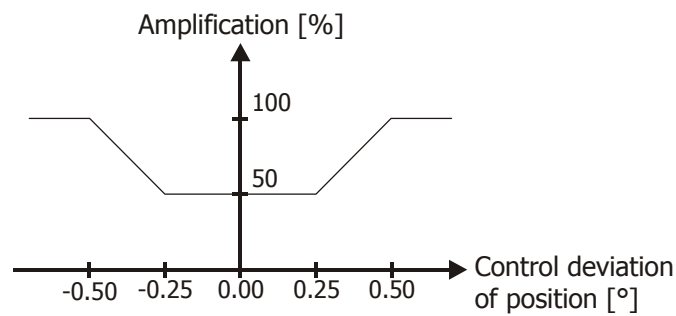

The following behavior may indicate that the controller parameters are not configured properly:

- drive is very loud
- drive vibrates
- frequent contouring errors
- inexact control

For the setting options of other control parameters, e.g. speed controller and acceleration pilot control, refer to the operating instructions of the frequency inverter.

Note: Optimize the settings in actual operating conditions, as control parameters for speed controller and acceleration pilot control depend on actual load. Optimize with different load types to obtain a good control behavior in all situations.

4.13 Store the actual position value (latching function)

With the latching function the actual position value of the drive can be stored. With a rising or falling signal edge at digital input S2IND the actual position value is stored in the EEPROM and displayed via *Latched Position 1281*.

Parameter *Operation Mode 1280* allows to set the storing of actual position value to rising or falling signal edge.

<i>Operation Mode 1280</i>	<i>Function</i>
0 - Off	The Latching function is switched off.
1 - S2IND Rising Edge	With a rising signal edge at digital input S2IND the actual position value is stored in the EEPROM and displayed via <i>Latched Position 1281</i> .
2 - S2IND Falling Edge	With a falling signal edge at digital input S2IND the actual position value is stored in the EEPROM and displayed via <i>Latched Position 1281</i> .

The latched position is available as signal source:

- Source "617 - Latched Position", for example as actual position value for the position comparator
- Source "617 - Latched Position" for transmission via systembus (TxPDO Long) in internal format
- Source "618 - Latched Position (User-Units)" for transmission via systembus (TxPDO Long) in user units
- Source "1028 (in user units) ... 1031 (in user units * 1000) for the scope function

The latched position is stored in the internal EEPROM during mains switch-off or mains failure. This enables resuming of interrupted movements.

Note: The function is permanently linked to digital input S2IND, parameterization on another digital input is not possible.

Consider the assignment of the digital input S2IND to other functions (for example to *Start Positioning 1222*) for the usage of the latching function. If applicable change the parameter assignment and wiring.

4.14 Wiring Example

ACU, device series ACTIVE Cube

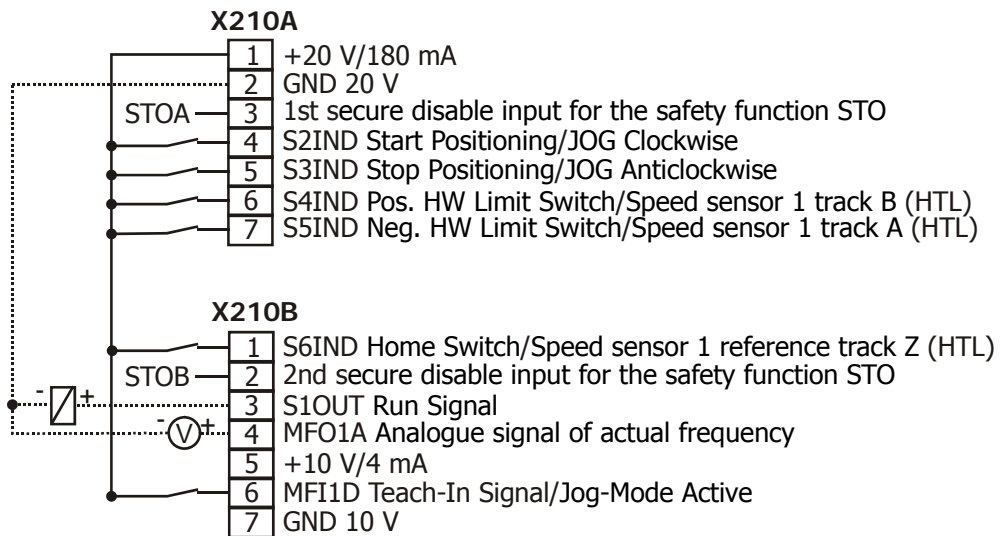

Expansion module EM-ENC-04 (optional)

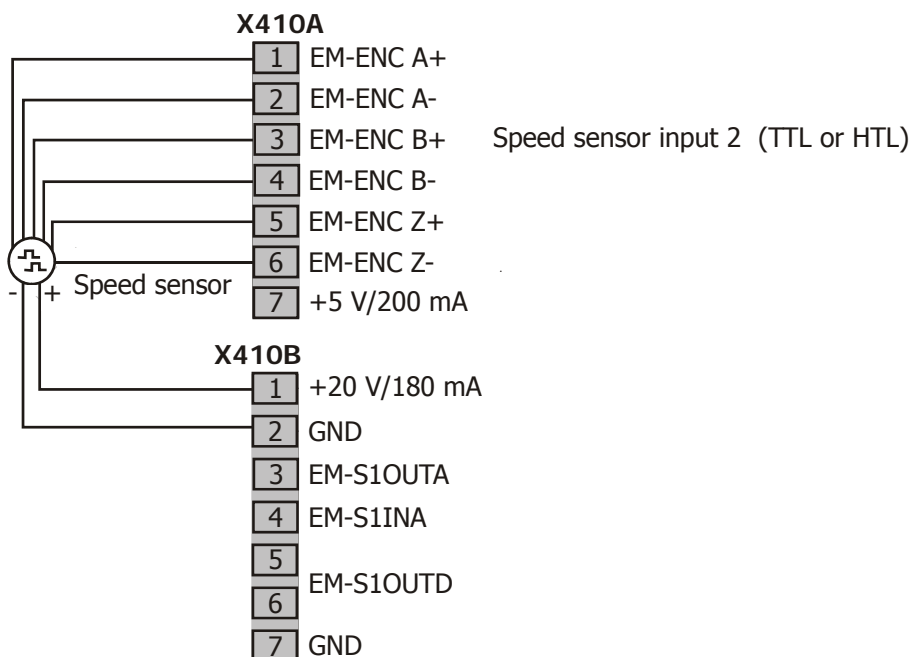

In configuration 240 S4IND (X210A.6) and S5IND (X210A.7) are parameterized by default as inputs for Encoder 1. Via S6IND (X210B.1), the zero track of a HTL encoder can be evaluated. Alternatively, the inputs of an optional extension module EM-ENC can be used as encoder inputs. In this case, inputs S4IND and S5IND must be parameterized for a changed assignment of functions.

In configuration 540, evaluation of Encoder 1 (parameter *Operation Mode 490*) is disabled by default, parameter *Act. Speed Source 766* is not available. Digital inputs S4IND (X210A.6) and S5IND (X210A.7) can be used as inputs for HW limit switches.

Configuration 540 enables evaluation of resolvers and requires an optional expansion module EM-RES.

Parameters for inputs:

Parameter		Setting/Selection		
30	Configuration	240	440, 540	
490	Operation Mode speed sensor 1	1 ... 1132	0 - Off	
766	Act. Speed Source	1 - Speed sensor 1 or 2 - Speed sensor 2 ¹⁾	2)	
1222	Start Positioning	71 - S2IND	↻ ❶	
1232	Jog Clockwise	71 - S2IND		
1223	Stop Positionierung	72 - S3IND	↻ ❷	
1233	Jog Anticlockwise	72 - S3IND		
			Fact. set.	Setting
1138	Positive HW Limit Switch	7 - Off	7 - Off	e.g. 540
1137	Negative HW Limit Switch	7 - Off	7 - Off	e.g. 541
1139	Home Switch	75 - S6IND		
1239	Teach-In-Signal	76 - MFI1D	↻ ❸	
1231	Jog-Mode Active	76 - MFI1D		

¹⁾ Only available in combination with extension module, e.g. EM-ENC/EM-RES.

²⁾ Configuration 540 requires an extension module EM-RES for evaluation of the resolver on the synchronous motor, is wired to this source internally and cannot be changed. Configuration 440 uses internal operands.

❶ Digital input S2IND has function "JOG Clockwise":

- If HIGH signal is present on MFI1D. MFI1D is assigned to parameter *Jog-Mode Active 1231* (factory settings).
- Automatically by setting parameter *Operation Mode 1221* to: "301 - Teach-In, Motion Block Sel. via Digital Inputs" or "302 - Teach-In, Motion Block Sel. via P. 1228".

❷ Digital input S3IND has function "JOG Anticlockwise":

- If HIGH signal is present on MFI1D. MFI1D is assigned to parameter *Jog-Mode Active 1231* (factory settings).
- Automatically by setting parameter *Operation Mode 1221* to: "301 - Teach-In, Motion Block Sel. via Digital Inputs" or "302 - Teach-In, Motion Block Sel. via P. 1228".

❸ JOG mode is switched on automatically by setting parameter *Operation Mode 1221* to:

- "301 - Teach-In, Motion Block Sel. via Digital Inputs" or
- "302 - Teach-In, Motion Block Sel. via P. 1228".

Digital input MFI1D is provided for connection of a teach-in signal in these settings (for saving current position as target position in motion block). In these settings, JOG mode does not have to be switched on separately via digital input MFI1D (parameter *Jog-Mode Active 1231*).

For all other settings of parameter *Operation Mode 1221*, digital input MFI1D is provided for activation of JOG mode.

5 List of homing modes

In the following sections, the homing modes are explained in detail. The sections are organized as follows:

- 5.1 Brief description
- 5.2 Overview table
- 5.3 Graphical overview
- 5.5 Detailed explanations

The graphic overview and overview table are recommended for experienced users who are already familiar with the functions of the different homing types. With these overviews, the correct mode for the application can be selected quickly. For a detailed functional description, refer to section 5.5.

5.1 Brief Description Homing

For parameter *Homing Mode* **1130** the following operation modes are available:

<i>Homing Mode</i> 1130		Function
0 -	No Homing	Factory setting. No homing; the current position value is not changed. The current position value is the value saved upon last disconnection of power supply.
1 -	Neg. Limit Switch & Ref. -Signal	Homing to negative HW limit switch with detection of encoder ref. signal.
2 -	Pos. Limit Switch & Ref. -Signal	Homing to positive HW limit switch with detection of encoder ref. signal.
3 -	Pos. Home-Sw., Ref.-Signal left of Edge	Homing to positive home switch with detection of encoder ref. signal. Home position is the first encoder ref. signal to the left of the edge of the home switch signal.
4 -	Pos. Home-Sw., Ref.-Signal right of Edge	Homing to positive home switch with detection of encoder ref. signal. Home position is the first encoder ref. signal to the right of the edge of the home switch signal.
5 -	Neg. Home-Sw., Ref.-Signal right of Edge	Homing to negative home switch with detection of encoder ref. signal. Home position is the first encoder ref. signal to the right of the edge of the home switch signal.
6 -	Neg. Home-Sw.: Ref.-Signal left of Edge	Homing to negative home switch with detection of encoder ref. signal. Home position is the first encoder ref. signal to the left of the edge of the home switch signal.
7 -	Pos. Lim.-Sw., Ref.-Sig. left of left Edge of Home-Sw.	Homing to home switch with detection of encoder ref. signal. Homing direction positive (clockwise).
8 -	Pos. Lim.-Sw., Ref.-Sig. right of left Edge of Home-Sw.	Reversal of direction of rotation when positive HW limit switch is reached.
9 -	Pos. Lim.-Sw., Ref.-Sig. left of right Edge of Home-Sw.	Home position is the first encoder ref. signal to the left or right of the left or right edge of the home switch signal.
10 -	Pos. Lim.-Sw., Ref.-Sig. right of right Edge of Home-Sw.	

<i>Homing Mode 1130</i>		<i>Function</i>
11 -	Neg. Lim.-Sw., Ref.-Sig. right of right Edge of Home-Sw.	Homing to home switch with detection of encoder ref. signal. Homing direction negative (anticlockwise). Reversal of direction of rotation when negative HW limit switch is reached. Home position is the first encoder ref. signal to the left or right of the left or right edge of the home switch signal.
12 -	Neg. Lim.-Sw., Ref.-Sig. left of right Edge of Home-Sw.	
13 -	Neg. Lim.-Sw., Ref.-Sig. right of left Edge of Home-Sw.	
14 -	Neg. Lim.-Sw., Ref.-Sig. left of left Edge of Home-Sw.	
17 ... 30: like 1 ... 14, but without encoder ref. signal		
17 -	Neg. Limit Switch	Homing to negative HW limit switch.
18 -	Pos. Limit Switch	Homing to positive HW limit switch.
19 -	Pos. Home-Sw., left of Edge	Homing to positive home switch. Home position is at the left of the edge of the home switch signal.
20 -	Pos. Home-Sw., right of Edge	Homing to positive home switch. Home position is at the right of the edge of the home switch signal.
21 -	Neg. Home-Sw., right of Edge	Homing to negative home switch. Home position is at the right of the edge of the home switch signal.
22 -	Neg. Home-Sw., left of Edge	Homing to negative home switch. Home position is at the left of the edge of the home switch signal.
23 -	Pos. Lim.-Sw., left of left Edge of Home-Sw.	Homing to home switch. Homing direction positive (clockwise). Reversal of direction of rotation when positive HW limit switch is reached. Home position is at the left or right of the left or right edge of the home switch signal.
24 -	Pos. Lim.-Sw., right of left Edge of Home-Sw.	
25 -	Pos. Lim.-Sw., left of right Edge of Home-Sw.	
26 -	Pos. Lim.-Sw., right of right Edge of Home-Sw.	
27 -	Neg. Lim.-Sw., right of right Edge of Home-Sw.	
28 -	Neg. Lim.-Sw., left of right Edge of Home-Sw.	
29 -	Neg. Lim.-Sw., right of left Edge of Home-Sw.	Homing to home switch. Homing direction negative (anticlockwise). Reversal of direction of rotation when negative HW limit switch is reached. Home position is at the left or right of the left or right edge of the home switch signal.
30 -	Neg. Lim.-Sw., left of left Edge of Home-Sw.	
33 -	Ref.-Signal left of act. pos.	Home position is the first encoder ref. signal in negative (operation mode 33) or positive (operation mode 34) direction.
34 -	Ref.-Signal right of act. pos.	
35 -	Current Position	Current position is home position. Home offset (Parameter <i>Home-Offset 1131</i>) is taken over as actual position value.

5.2 Overview Table of Homing Types

The following table provides an overview of which position is approached and which limit switch is used for reversal of the direction of rotation.

No.	Main destination		Fine destination (Ref. signal)	Limit Switch ?
1	Left	limit switch	Ref. signal right	Left limit switch
2	Right		Ref. signal left	Right limit switch
3	Negative	home switch	Ref. signal left	Without limit switch
4			Ref. signal right	
5	Positive		Ref. signal right	
6			Ref. signal left	
7	Left edge	home switch	Ref. signal left	Right limit switch
8	Right edge		Ref. signal right	
9			Ref. signal left	
10	Right edge		Ref. signal right	Left limit switch
11			Ref. signal right	
12			Ref. signal left	
13	Left edge	Ref. signal right	Left limit switch	
14		Ref. signal left		
15	<i>Reserved</i>			
16	<i>Reserved</i>			
17	Left	limit switch	Falling edge	Left limit switch
18	Right		Falling edge	Right limit switch
19	Negative	home switch	Falling edge	Without limit switch
20			Rising edge	
21	Positive		Falling edge	
22			Rising edge	
23	Left edge	home switch	Falling edge	Right limit switch
24	Right edge		Rising edge	
25			Rising edge	
26	Right edge		Falling edge	Left limit switch
27			Falling edge	
28			Rising edge	
29	Left edge	Rising edge	Left limit switch	
30		Falling edge		
31	<i>Reserved</i>			
32	<i>Reserved</i>			
33	Left	ref. signal		
34	Right			
35	Current	position		

Note: Homing types 17 to 30 do not evaluate any encoder ref. signal.

5.3 Graphic Overview of Homing Modes

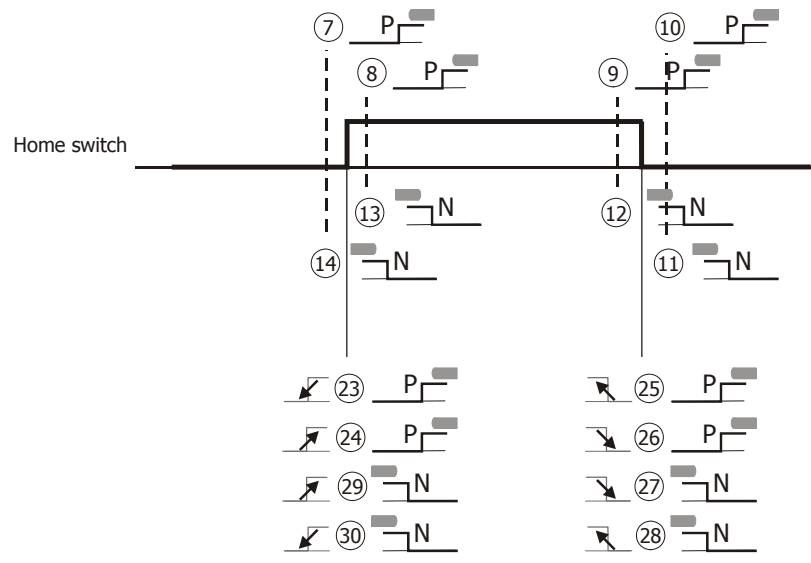
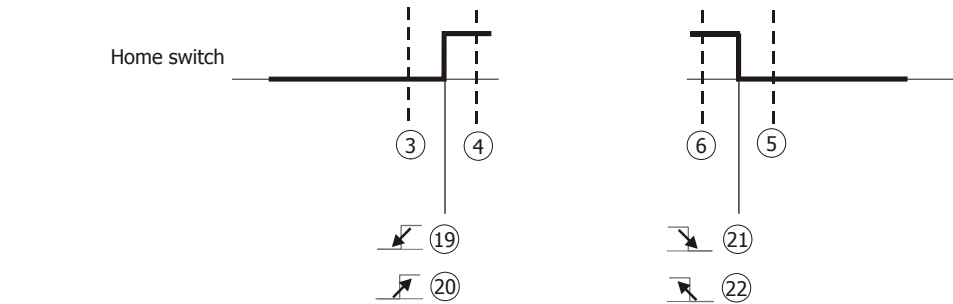
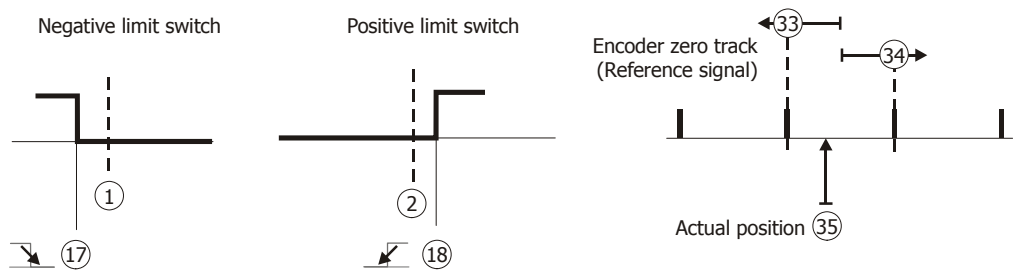

	Zero track left or right of edge	①	Number of homing mode
	Destination approached from left upon rising edge. When coming from the right, direction is reversed when passing the edge.		
	Destination approached from right upon falling edge. When coming from the left, direction is reversed when passing the edge.		
	Destination approached from right upon rising edge. When coming from the left, direction is reversed when passing the edge.		
	Destination approached from left upon falling edge. When coming from the right, direction is reversed when passing the edge.		
	Positive hardware limit switch is used for reversal of direction of rotation.		
	Negative hardware limit switch is used for reversal of direction of rotation.		

5.4 Terminology

To enable a better understanding of the homing modes, the terms used are explained in the following.

Home switch	active = 1	"High" signal is present
	inactive = 0	"Low" signal is present
	not used	In this homing mode, no home switch is used
Limit switch		Travel limit.
Hardware limit switches		Travel limit. Design: Initiators connected to digital inputs.
Software limit switches		Travel limit, managed centrally in frequency inverter. Only active after homing. Software limit switches stop the travel operation before the hardware limit switches as an additional safety function.
Ref. signal		Pulse which occurs once every encoder rotation. Increases homing accuracy.
Direction of rotation reversal		The search direction is changed when a status change (e.g. "limit switch reached") has occurred. This indicates that the home position is in opposite direction.
Search direction	Positive direction	Motor turns in positive direction (clockwise when looking at shaft).
	Negative direction	Motor turns in negative direction (anticlockwise when looking at shaft).
Edge	Rising edge	Status change of a signal from "0" to "1".
	Falling edge	Status change of a signal from "1" to "0".
	Left edge	Status change of a signal from "1" to "0" or "0" to "1" in the case of a cam on the left side.
	Right edge	Status change of a signal from "1" to "0" or "0" to "1" in the case of a cam on the right side.
Speed	Fast speed	High speed at which the target is searched at the beginning.
	Creep speed	Low speed at which the target is approached exactly.

5.5 Description of Homing Modes

Application example setup:

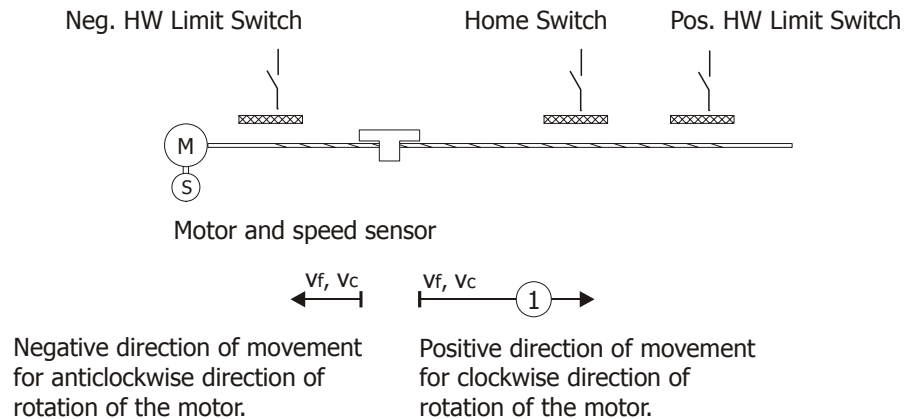

└─ Initial position of the homing

v_f Fast Speed

v_c Creep Speed

① ... ③⑤ Operation modes of parameter *Homing Mode* 1130

The homing modes are described in tables, graphically and in texts. The terms and symbols are used uniformly.

In some homing modes, a limit switch is used for reversing the direction of rotation. This is either the positive or the negative limit switch. If the limit switch selected is actuated, the direction of rotation is reversed. In some cases, this also causes a speed change. If the other (non-selected) limit switch is actuated, the corresponding error message is triggered).

Note: BONFIGLIOLI VECTRON recommends that wire break proof limit switches be used ("0 - active").

Note: The homing types are based on the CANopen specification DSP 4.02.

5.5.1 Homing Modes with Ref. Signal

Operation mode 1: Homing to negative limit switch with detection of encoder ref. signal

Dest.:	Ref. signal to the right of negative limit switch	
	Home switch not used	
	Search direction	Negative direction
	Speed (before reversal of direction of rotation)	<i>Fast Speed 1132</i>
	Condition reversal of direction of rotation	Rising edge negative limit switch
	Speed (after reversal of direction of rotation)	<i>Creep Speed 1133</i>

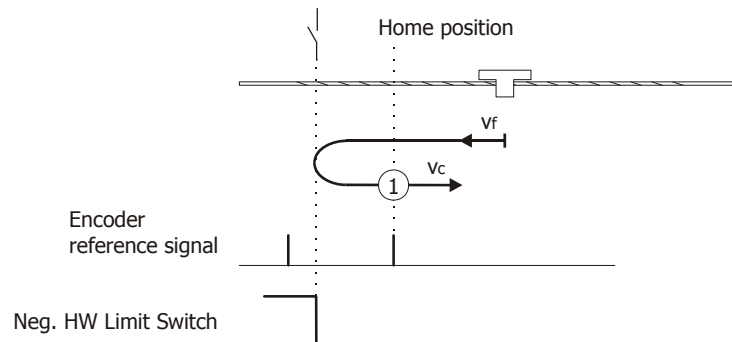

The homing direction (search direction) is negative at *Fast Speed 1132*. When the limit switch is reached, the direction of rotation is reversed and homing is performed at *Creep Speed 1133*.

The home position is the first encoder ref. signal after the falling edge of the limit switch when traveling in positive direction (clockwise).

Operation mode 2: Homing to positive limit switch with detection of encoder ref. signal

Dest.:	Ref. signal to the left of positive limit switch	
	Home switch not used	
	Search direction	Positive direction
	Speed (before reversal of direction of rotation)	<i>Fast Speed 1132</i>
	Condition reversal of direction of rotation	Rising edge positive limit switch
	Speed (after reversal of direction of rotation)	<i>Creep Speed 1133</i>

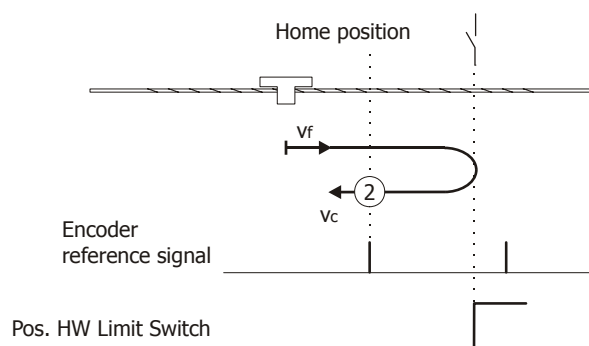

The homing direction (search direction) is positive at *Fast Speed 1132*. When the limit switch is reached, the direction of rotation is reversed and homing is performed at *Creep Speed 1133*.

The home position is the first encoder ref. signal after the falling edge of the limit switch when traveling in negative direction (anticlockwise).

Operation mode 3: Homing to positive home switch with detection of encoder ref. signal, home position is the first ref. signal after the home switch signal has changed

Dest.:	Ref. signal to left of left edge of positive home switch	
A	Home switch inactive	0
	Search direction	Positive direction
	Speed (before reversal of direction of rotation)	<i>Fast Speed 1132</i>
	Condition reversal of direction of rotation	Rising edge home switch
	Speed (after reversal of direction of rotation)	<i>Creep Speed 1133</i>
B	Home switch active	1
	Search direction	Negative direction
	Speed	<i>Creep Speed 1133</i>

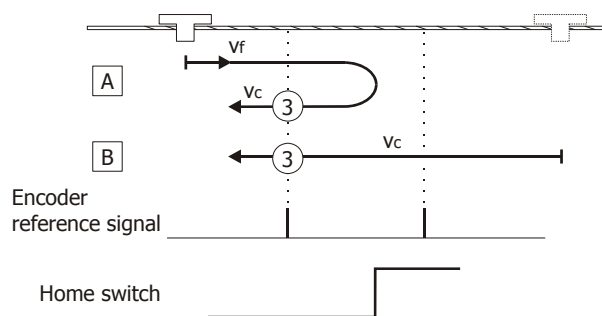

The homing direction (search direction) depends on the signal status of the home switch.

A: Homing direction is positive if the home switch is inactive. Travel to home switch is performed at *Fast Speed 1132*. When the home switch is reached, the direction of rotation is reversed. Home position is the first encoder ref. signal after the falling edge of the home switch signal. Search for the home position is performed at *Creep Speed 1133*.

B: Homing direction is negative if the home switch is active. Home position is the first encoder ref. signal after the status change of the home switch signal. Search for the home position is performed at *Creep Speed 1133*.

Operation mode 4: Homing to positive home switch with detection of encoder ref. signal, home position is the first ref. signal after the home switch signal has changed

Dest.:	Ref. signal to right of left edge of positive home switch	
A	Home switch inactive	0
	Search direction	Positive direction
	Speed	<i>Creep Speed 1133</i>
B	Home switch active	1
	Search direction	Negative direction
	Speed (before reversal of direction of rotation)	<i>Fast Speed 1132</i>
	Condition reversal of direction of rotation	Falling edge home switch
	Speed (after reversal of direction of rotation)	<i>Creep Speed 1133</i>

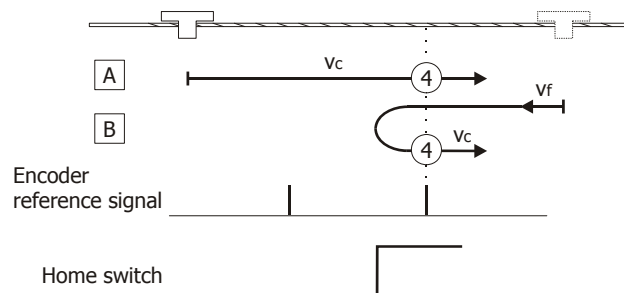

The homing direction (search direction) depends on the signal status of the home switch.

A: Homing direction is positive if the home switch is inactive. Home position is the first encoder ref. signal after the home switch is reached. Search for the home position is performed at *Creep Speed 1133*.

B: Homing direction is negative if the home switch is active. Travel to falling edge of home switch is performed at *Fast Speed 1132*. When the home switch is passed, the direction of rotation is reversed. Home position is the first encoder ref. signal after the rising edge of the home switch signal. Search for the home position is performed at *Creep Speed 1133*.

Operation mode 5: Homing to negative home switch with detection of encoder ref. signal, home position is the first ref. signal after the home switch signal has changed

Dest.:	Ref. signal to right of left edge of negative home switch	
A	Home switch active	1
	Search direction	Positive direction
	Speed	<i>Creep Speed 1133</i>
B	Home switch inactive	0
	Search direction	Negative direction
	Speed (before reversal of direction of rotation)	<i>Fast Speed 1132</i>
	Condition reversal of direction of rotation	Rising edge home switch
	Speed (after reversal of direction of rotation)	<i>Creep Speed 1133</i>

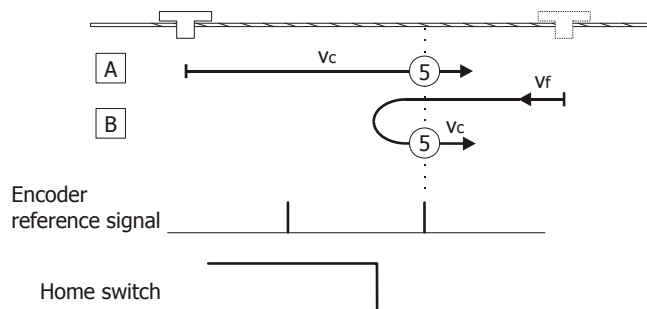

The homing direction (search direction) depends on the signal status of the home switch.

A: Homing direction is positive if the home switch is active. Home position is the first encoder ref. signal after the falling edge of the home switch signal. Search for the home position is performed at *Creep Speed 1133*.

B: Homing direction is negative if the home switch is inactive. Travel to home switch is performed at *Fast Speed 1132*. When the home switch is reached, the direction of rotation is reversed. Home position is the first encoder ref. signal after the falling edge of the home switch signal. Search for the home position is performed at *Creep Speed 1133*.

Operation mode 6: Homing to negative home switch with detection of encoder ref. signal, home position is the first ref. signal after the home switch signal has changed

Dest.:	Ref. signal to left of right edge of negative home switch	
A	Home switch active	1
	Search direction	Positive direction
	Speed (before reversal of direction of rotation)	<i>Fast Speed 1132</i>
	Condition reversal of direction of rotation	Falling edge home switch
	Speed (after reversal of direction of rotation)	<i>Creep Speed 1133</i>
B	Home switch inactive	0
	Search direction	Negative direction
	Speed	<i>Creep Speed 1133</i>

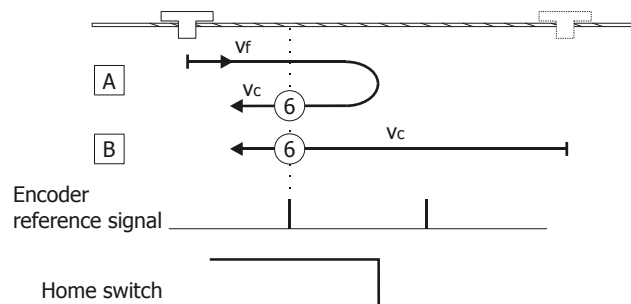

The homing direction (search direction) depends on the signal status of the home switch.

A: Homing direction is positive if the home switch is active. Travel to falling edge of home switch is performed at *Fast Speed 1132*. When the home switch is passed, the direction of rotation is reversed. Home position is the first encoder ref. signal after the rising edge of the home switch signal. Search for the home position is performed at *Creep Speed 1133*.

B: Homing direction is negative if the home switch is inactive. Home position is the first encoder ref. signal after the rising edge of the home switch signal. Search for the home position is performed at *Creep Speed 1133*.

Operation mode 7: Homing to home switch with detection of encoder ref. signal, homing direction positive (clockwise), reversal of direction of rotation when positive HW limit switch is reached

Dest.:	Ref. signal to left of left edge of home switch	
A	Home switch inactive	0
	Search direction	Positive direction
	Speed (before reversal of direction of rotation)	<i>Fast Speed 1132</i>
	Condition reversal of direction of rotation	Rising edge home switch
	Speed (after reversal of direction of rotation)	<i>Creep Speed 1133</i>
B	Home switch active	1
	Search direction	Negative direction
	Speed	<i>Creep Speed 1133</i>
C	Home switch inactive	0
	Search direction	Positive direction
	Speed (before reversal of direction of rotation)	<i>Fast Speed 1132</i>
	Condition reversal of direction of rotation	Rising edge positive HW limit switch
	Speed (after reversal of direction of rotation)	<i>Fast Speed 1132</i>
	Condition speed change	Rising edge home switch
	Speed (after speed change)	<i>Creep Speed 1133</i>

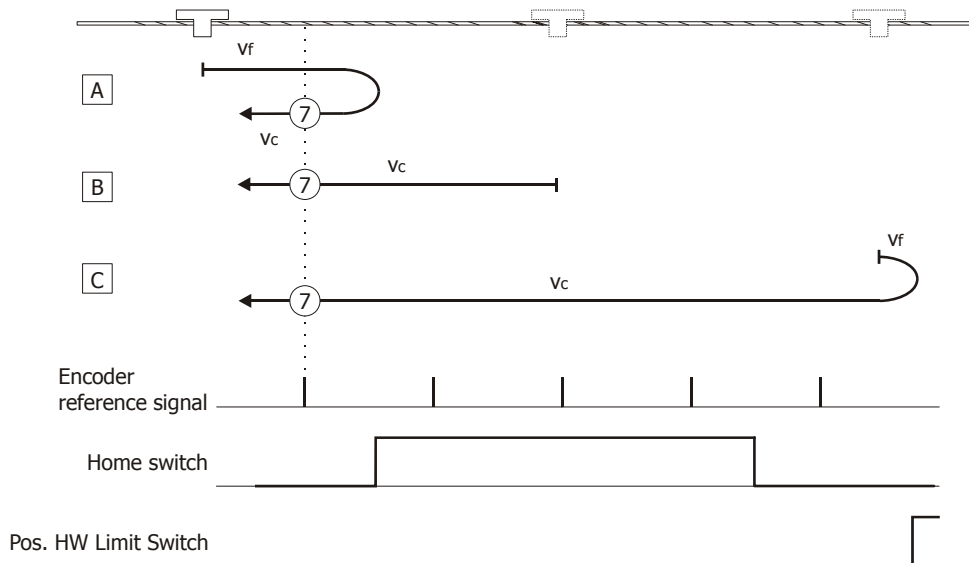

The homing direction (search direction) depends on the signal status of the home switch.

A: Homing direction (search direction) is clockwise toward positive HW limit switch if home switch and limit switch are inactive. The home switch is in search direction. Travel to rising edge of home switch is performed at *Fast Speed 1132*. When the home switch is reached, the direction of rotation is reversed. Home position is the first encoder ref. signal after the falling edge of the home switch signal. Search for the home position is performed at *Creep Speed 1133*.

B: When homing is started, the home switch is active. Homing direction (search direction) is anticlockwise toward negative HW limit switch. Home position is the first encoder ref. signal after the home switch is passed in negative direction. Search for the home position is performed at *Creep Speed 1133*.

C: Homing direction (search direction) is clockwise toward positive HW limit switch. The home switch is not in search direction. The positive limit switch acts as a reversing switch. When the positive limit switch is reached, the direction of rotation is reversed, and homing is performed in negative direction. Travel to rising edge of home switch is performed at *Fast Speed 1132*. Home position is the first encoder ref. signal after the home switch is passed. Search for the home position is performed at *Creep Speed 1133*.

Operation mode 8: Homing to home switch with detection of encoder ref. signal, homing direction positive (clockwise), reversal of direction of rotation when positive HW limit switch is reached

Dest.:	Ref. signal to right of left edge of home switch	
A	Home switch inactive	0
	Search direction	Positive direction
	Speed	<i>Fast Speed 1132</i>
B	Home switch active	1
	Search direction	Negative direction
	Speed (before reversal of direction of rotation)	<i>Fast Speed 1132</i>
	Condition reversal of direction of rotation	Falling edge home switch
	Speed (after reversal of direction of rotation)	<i>Creep Speed 1133</i>
C	Home switch inactive	0
	Search direction	Positive direction
	Speed (before reversal of direction of rotation)	<i>Fast Speed 1132</i>
	Condition reversal of direction of rotation	Rising edge positive HW limit switch
	Speed (after reversal of direction of rotation)	<i>Fast Speed 1132</i>
	Condition reversal of direction of rotation	Falling edge home switch
	Speed (after reversal of direction of rotation)	<i>Creep Speed 1133</i>

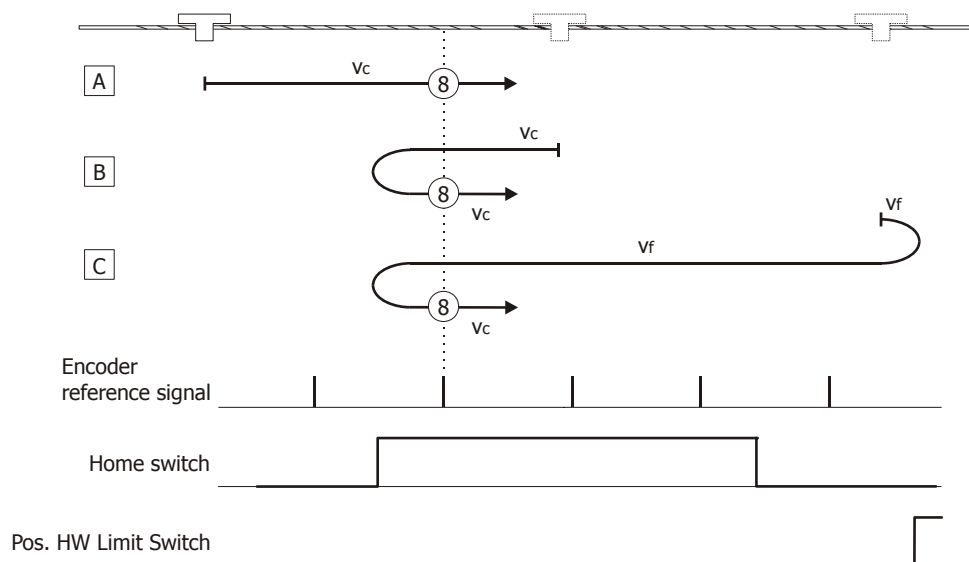

The homing direction (search direction) depends on the signal status of the home switch.

A: Homing direction (search direction) is clockwise toward positive HW limit switch if home switch and limit switch are inactive. The home switch is in search direction. Home position is the first encoder ref. signal after the home switch is reached. During the whole operation, homing is performed at *Fast Speed 1132*.

B: When homing is started, the home switch is active. Homing direction (search direction) is anticlockwise toward negative HW limit switch. Travel to falling edge of home switch is performed at *Fast Speed 1132*. When the home switch is passed in negative direction, the direction of rotation is reversed. Home position is the next encoder ref. signal. Search for the home position is performed at *Creep Speed 1133*.

C: Homing direction (search direction) is clockwise toward positive HW limit switch. The home switch is not in search direction. The positive limit switch acts as a reversing switch. When the positive limit switch is reached, the direction of rotation is reversed, and homing is performed in negative direction. Travel to falling edge of home switch is performed at *Fast Speed 1132*. When the home switch is passed, the direction of rotation is reversed again. Home position is the first encoder ref. signal after the status change of the home switch signal when traveling in positive direction. Search for the home position is performed at *Creep Speed 1133*.

Operation mode 9: Homing to home switch with detection of encoder ref. signal, homing direction positive (clockwise), reversal of direction of rotation when positive HW limit switch is reached

Dest.:	Ref. signal to left of right edge of home switch	
A	Home switch inactive	0
	Search direction	Positive direction
	Speed (before reversal of direction of rotation)	<i>Fast Speed 1132</i>
	Condition reversal of direction of rotation	Falling edge home switch
	Speed (after reversal of direction of rotation)	<i>Creep Speed 1133</i>
B	Home switch active	1
	Search direction	Positive direction
	Speed (before reversal of direction of rotation)	<i>Fast Speed 1132</i>
	Condition reversal of direction of rotation	Falling edge home switch
	Speed (after reversal of direction of rotation)	<i>Creep Speed 1133</i>
C	Home switch inactive	0
	Search direction	Positive direction
	Speed (before reversal of direction of rotation)	<i>Fast Speed 1132</i>
	Condition reversal of direction of rotation	Rising edge positive HW limit switch
	Speed (after reversal of direction of rotation)	<i>Fast Speed 1132</i>

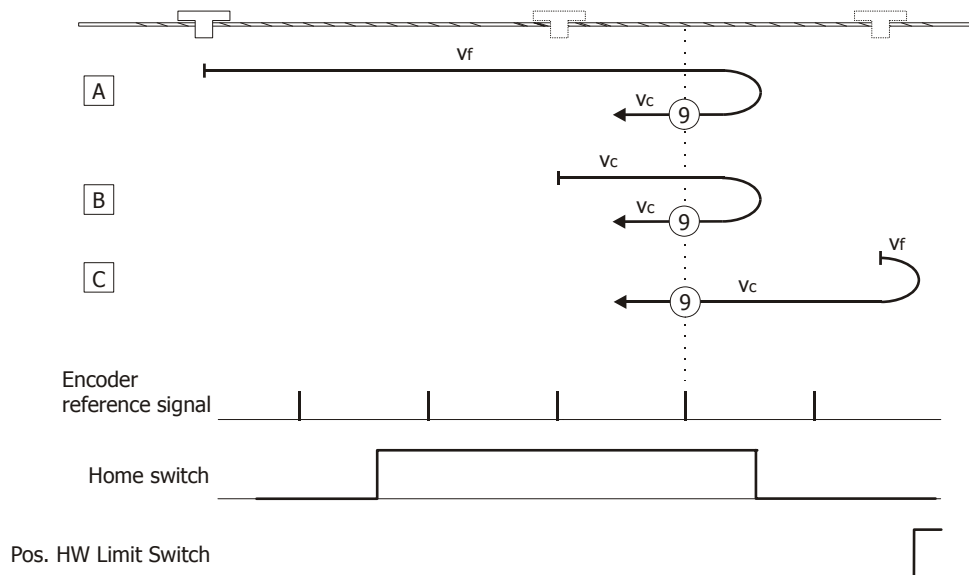

A: Homing direction (search direction) is clockwise toward positive HW limit switch if home switch and limit switch are inactive. The home switch is in search direction. Travel to falling edge of home switch is performed at *Fast Speed 1132*. When the home switch is passed, the direction of rotation is reversed. Home position is the next encoder ref. signal. Search for the home position is performed at *Creep Speed 1133*.

B: When homing is started, the home switch is active. Homing direction (search direction) is clockwise toward positive HW limit switch. Travel to falling edge of home switch is performed at *Fast Speed 1132*. When the home switch is passed in positive direction, the direction of rotation is reversed. Home position is the next encoder ref. signal. Homing is performed at *Creep Speed 1133*.

C: Homing direction (search direction) is clockwise toward positive HW limit switch. The home switch is not in search direction. The positive limit switch acts as a reversing switch. When the positive limit switch is reached, the direction of rotation is reversed, and homing is performed in negative direction. Home position is the first encoder ref. signal after the home switch is reached. During the whole operation, homing is performed at *Fast Speed 1132*.

Operation mode 10: Homing to home switch with detection of encoder ref. signal, homing direction positive (clockwise), reversal of direction of rotation when positive HW limit switch is reached

Dest.:	Ref. signal to left of left edge of home switch	
A	Home switch inactive	0
	Search direction	Positive direction
	Speed (before speed change)	<i>Fast Speed 1132</i>
	Condition speed change	Rising edge home switch
	Speed (after speed change)	<i>Creep Speed 1133</i>
B	Home switch active	1
	Search direction	Positive direction
	Speed	<i>Creep Speed 1133</i>
C	Home switch inactive	0
	Search direction	Positive direction
	Speed (before reversal of direction of rotation)	<i>Fast Speed 1132</i>
	Condition reversal of direction of rotation	Rising edge positive HW limit switch
	Speed (after reversal of direction of rotation)	<i>Fast Speed 1132</i>
	Condition reversal of direction of rotation	Rising edge home switch
	Speed (after reversal of direction of rotation)	<i>Creep Speed 1133</i>

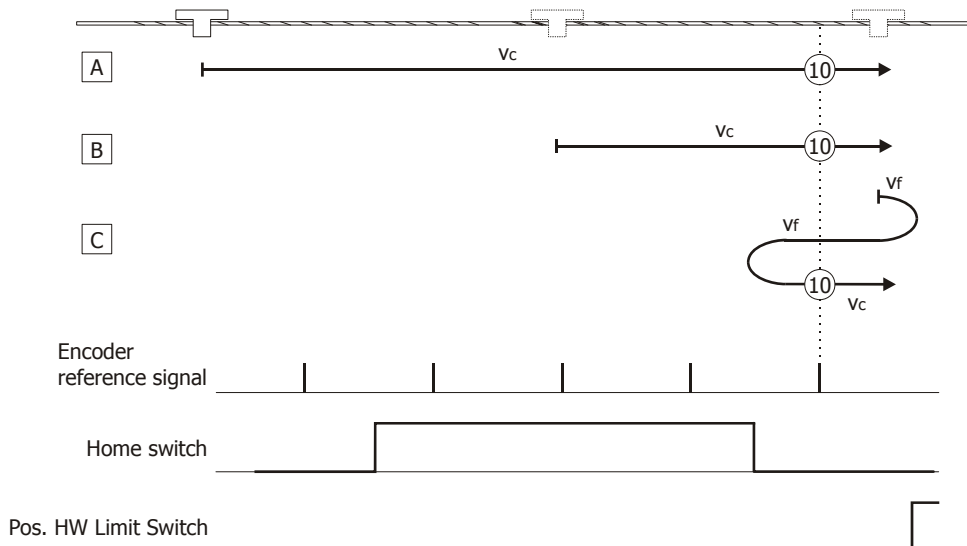

A: Homing direction (search direction) is clockwise toward positive HW limit switch if home switch and limit switch are inactive. The home switch is in search direction. Home position is the first encoder ref. signal after the home switch is passed. Travel to rising (left) edge of home switch is performed at *Fast Speed 1132*. Search for the home position is performed at *Creep Speed 1133*.

B: When homing is started, the home switch is active. Homing direction (search direction) is clockwise toward positive HW limit switch. Home position is the first encoder ref. signal after the home switch is passed in positive direction. Search for the home position is performed at *Creep Speed 1133*.

C: Homing direction (search direction) is clockwise toward positive HW limit switch. The home switch is not in search direction. The positive limit switch acts as a reversing switch. When the positive limit switch is reached, the direction of rotation is reversed, and homing is performed in negative direction. When the home switch is reached, the direction of rotation is reversed again. Home position is the first encoder ref. signal after the status change of the home switch signal when traveling in positive direction. Travel to rising (right) edge of home switch is performed at *Fast Speed 1132*. Search for the home position is performed at *Creep Speed 1133*.

Operation mode 11: Homing to home switch with detection of encoder ref. signal, homing direction negative (anticlockwise), reversal of direction of rotation when negative HW limit switch is reached

Dest.:	Ref. signal to right of right edge of home switch	
A	Home switch inactive	0
	Search direction	Negative direction
	Speed (before reversal of direction of rotation)	<i>Fast Speed 1132</i>
	Condition reversal of direction of rotation	Rising edge home switch
	Speed (after reversal of direction of rotation)	<i>Creep Speed 1133</i>
B	Home switch active	1
	Search direction	Positive direction
	Speed	<i>Creep Speed 1133</i>
C	Home switch inactive	0
	Search direction	Positive direction
	Speed (before reversal of direction of rotation)	<i>Fast Speed 1132</i>
	Condition reversal of direction of rotation	Rising edge negative HW limit switch
	Speed (after reversal of direction of rotation)	<i>Fast Speed 1132</i>
	Condition speed change	Rising edge home switch
	Speed (after speed change)	<i>Creep Speed 1133</i>

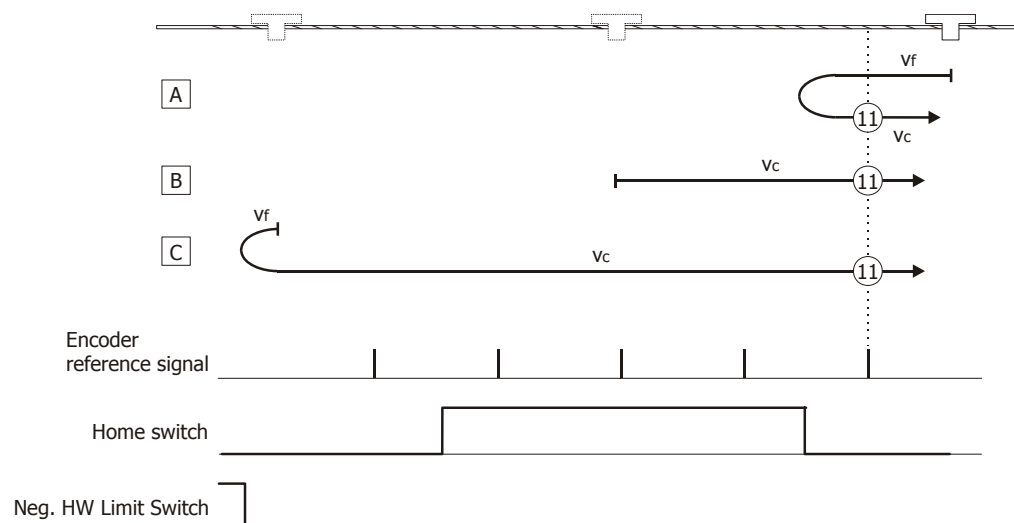

A: Homing direction (search direction) is anticlockwise toward negative HW limit switch if home switch and limit switch are inactive. The home switch is in search direction. Travel to right edge of home switch is performed at *Fast Speed 1132*. When the home switch is reached, the direction of rotation is reversed. Home position is the first encoder ref. signal after travel in positive direction. Search for the home position is performed at *Creep Speed 1133*.

B: When homing is started, the home switch is active. Homing direction (search direction) is clockwise toward positive HW limit switch. Home position is the first encoder ref. signal after the home switch is passed in positive direction. Homing is performed at *Creep Speed 1133*.

C: Homing direction (search direction) is anticlockwise toward negative HW limit switch. The home switch is not in search direction. The negative limit switch acts as a reversing switch. When the negative limit switch is reached, the direction of rotation is reversed, and homing is performed in positive direction. At first, the operation is performed at *Fast Speed 1132*, when the left edge of the home switch is reached, the speed is changed to *Creep Speed 1133*. Home position is the first encoder ref. signal after the right edge of the home switch is passed.

Operation mode 12: Homing to home switch with detection of encoder ref. signal, homing direction negative (anticlockwise), reversal of direction of rotation when negative HW limit switch is reached

Dest.:	Ref. signal to left of right edge of home switch	
A	Home switch inactive	0
	Search direction	Negative direction
	Speed	<i>Fast Speed 1132</i>
B	Home switch active	1
	Search direction	Positive direction
	Speed (before reversal of direction of rotation)	<i>Fast Speed 1132</i>
	Condition reversal of direction of rotation	Falling edge home switch
	Speed (after reversal of direction of rotation)	<i>Creep Speed 1133</i>
C	Home switch inactive	0
	Search direction	Negative direction
	Speed (before reversal of direction of rotation)	<i>Fast Speed 1132</i>
	Condition reversal of direction of rotation	Rising edge negative HW limit switch
	Speed (after reversal of direction of rotation)	<i>Fast Speed 1132</i>
	Condition reversal of direction of rotation	Rising edge home switch
	Speed (after reversal of direction of rotation)	<i>Creep Speed 1133</i>

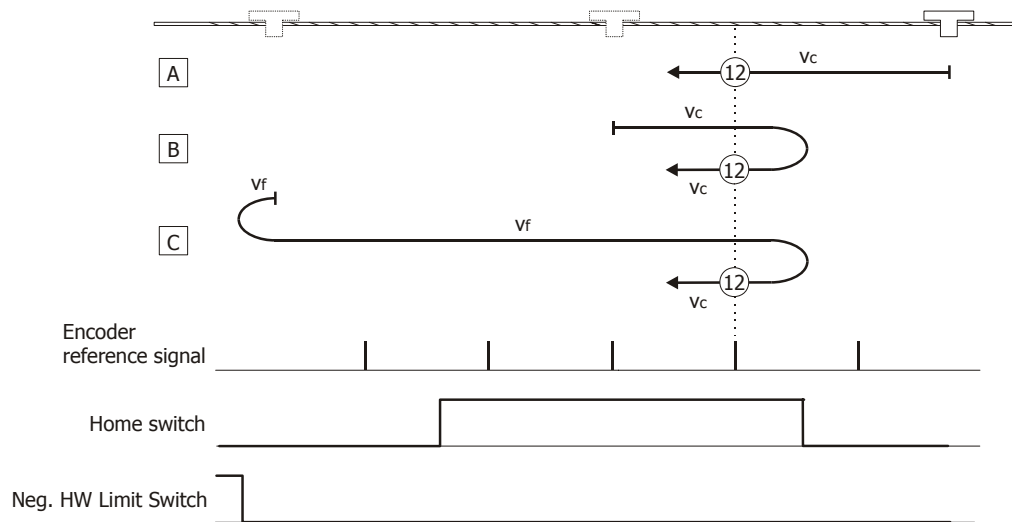

A: Homing direction (search direction) is anticlockwise toward negative HW limit switch if home switch and limit switch are inactive. The home switch is in search direction. Home position is the first encoder ref. signal after the home switch is reached. During the operation, homing is performed at *Fast Speed 1132*.

B: When homing is started, the home switch is active. Homing direction (search direction) is clockwise toward positive HW limit switch. Travel to falling edge of home switch is performed at *Fast Speed 1132*. When the home switch is passed in positive direction, the direction of rotation is reversed. Home position is the first encoder ref. signal after traveling in negative direction. Homing is performed at *Creep Speed 1133*.

C: Homing direction (search direction) is anticlockwise toward negative HW limit switch. The home switch is not in search direction. The negative limit switch acts as a reversing switch. When the negative limit switch is reached, the direction of rotation is reversed, and homing is performed in positive direction. When the home switch is passed, the direction of rotation is reversed again. Home position is the first encoder ref. signal after traveling in negative direction. Travel to right edge of home switch is performed at *Fast Speed 1132*. Search for the home position is performed at *Creep Speed 1133*.

Operation mode 13: Homing to home switch with detection of encoder ref. signal, homing direction negative (anticlockwise), reversal of direction of rotation when negative HW limit switch is reached

Dest.:	Ref. signal to right of left edge of home switch	
A	Home switch inactive	0
	Search direction	Negative direction
	Speed (before reversal of direction of rotation)	<i>Fast Speed 1132</i>
	Condition reversal of direction of rotation	Falling edge home switch
	Speed (after reversal of direction of rotation)	<i>Creep Speed 1133</i>
B	Home switch active	1
	Search direction	Negative direction
	Speed (before reversal of direction of rotation)	<i>Fast Speed 1132</i>
	Condition reversal of direction of rotation	Falling edge home switch
	Speed (after reversal of direction of rotation)	<i>Creep Speed 1133</i>
C	Home switch inactive	0
	Search direction	Negative direction
	Speed (before reversal of direction of rotation)	<i>Fast Speed 1132</i>
	Condition reversal of direction of rotation	Rising edge negative HW limit switch
	Speed (after reversal of direction of rotation)	<i>Fast Speed 1132</i>

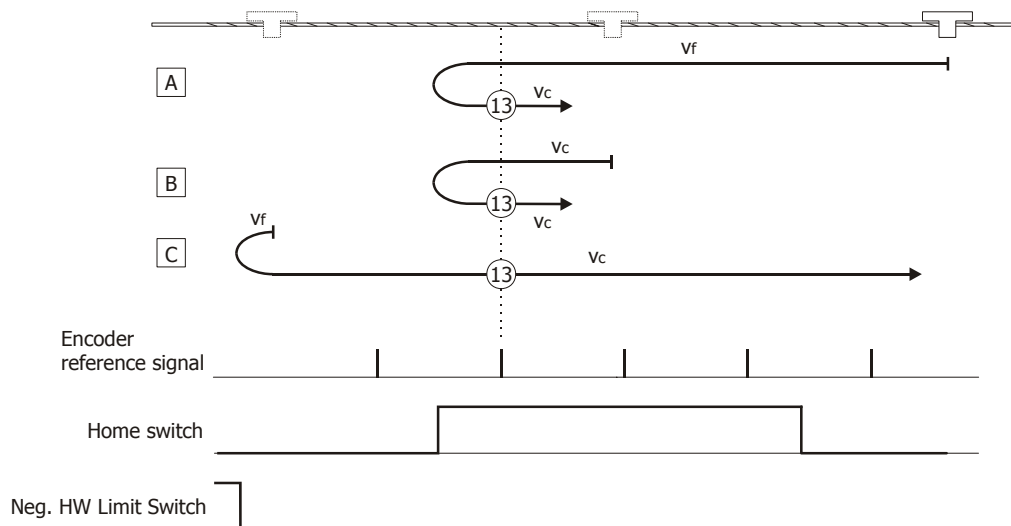

A: Homing direction (search direction) is anticlockwise toward negative HW limit switch if home switch and limit switch are inactive. The home switch is in search direction. Travel to left edge of home switch is performed at *Fast Speed 1132*. When the home switch is passed, the direction of rotation is reversed. Home position is the first encoder ref. signal after travel in positive direction. Search for the home position is performed at *Creep Speed 1133*

B: When homing is started, the home switch is active. Homing direction (search direction) is anticlockwise toward negative HW limit switch. Travel to left edge of home switch is performed at *Fast Speed 1132*. When the home switch is passed in negative direction, the direction of rotation is reversed. Home position is the first encoder ref. signal after traveling in positive direction. Homing is performed at *Creep Speed 1133*.

C: Homing direction (search direction) is anticlockwise toward negative HW limit switch. The home switch is not in search direction. The positive limit switch acts as a reversing switch. When the negative limit switch is reached, the direction of rotation is reversed, and homing is performed in positive direction. Home position is the first encoder ref. signal after the home switch is reached. During the whole operation, homing is performed at *Fast Speed 1132*.

Operation mode 14: Homing to home switch with detection of encoder ref. signal, homing direction negative (anticlockwise), reversal of direction of rotation when negative HW limit switch is reached

Dest.:	Ref. signal to left of left edge of home switch	
A	Home switch inactive	0
	Search direction	Negative direction
	Speed (before speed change)	<i>Fast Speed 1132</i>
	Condition speed change	Rising edge home switch
	Speed (after speed change)	<i>Creep Speed 1133</i>
B	Home switch active	1
	Search direction	Negative direction
	Speed	<i>Creep Speed 1133</i>
C	Home switch inactive	0
	Search direction	Negative direction
	Speed (before reversal of direction of rotation)	<i>Fast Speed 1132</i>
	Condition reversal of direction of rotation	Rising edge negative HW limit switch
	Speed (after reversal of direction of rotation)	<i>Fast Speed 1132</i>
	Condition reversal of direction of rotation	Rising edge home switch
	Speed (after reversal of direction of rotation)	<i>Creep Speed 1133</i>

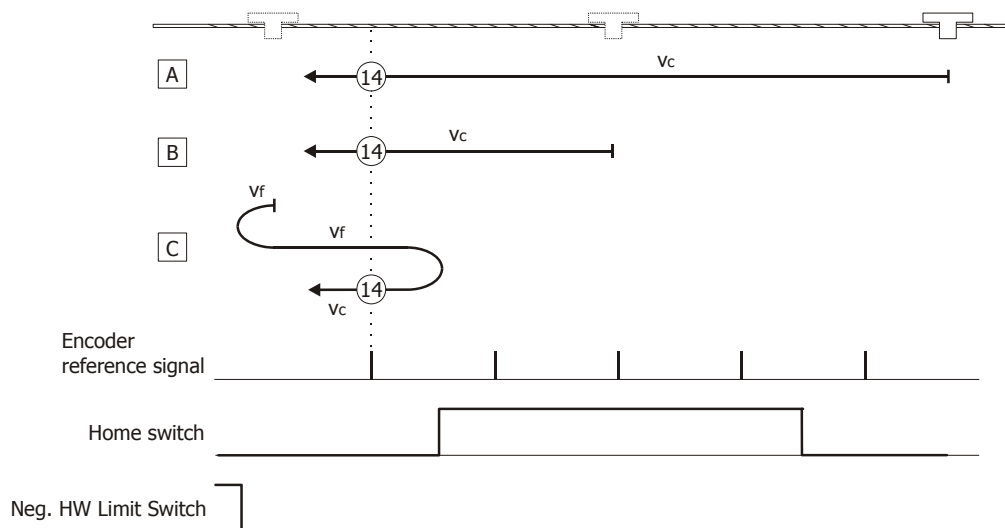

A: Homing direction (search direction) is anticlockwise toward negative HW limit switch if home switch and limit switch are inactive. The home switch is in search direction. Travel to rising (right) edge of home switch is performed at *Fast Speed 1132*. Home position is the first encoder ref. signal after the home switch is passed. Search for the home position is performed at *Creep Speed 1133*.

B: When homing is started, the home switch is active. Homing direction (search direction) is anticlockwise toward negative HW limit switch. Home position is the first encoder ref. signal after the home switch is passed in negative direction. Homing is performed at *Creep Speed 1133*.

C: Homing direction (search direction) is anticlockwise toward negative HW limit switch. The home switch is not in search direction. The negative limit switch acts as a reversing switch. When the negative limit switch is reached, the direction of rotation is reversed, and homing is performed in positive direction. When the home switch is reached, the direction of rotation is reversed again. At first, the operation is performed at *Fast Speed 1132*, when the left edge of the home switch is reached, the speed is changed to *Creep Speed 1133*. Home position is the first ref. signal in negative direction after the falling edge of the home switch signal.

5.5.2 Homing modes without reference signal

Operation mode 17: Homing to negative HW limit switch without encoder ref. signal.

Dest.:	Negative limit switch	
	Home switch active	
	Search direction	Negative direction
	Speed (before reversal of direction of rotation)	<i>Fast Speed 1132</i>
	Condition reversal of direction of rotation	Rising edge negative limit switch
	Speed (after reversal of direction of rotation)	<i>Creep Speed 1133</i>

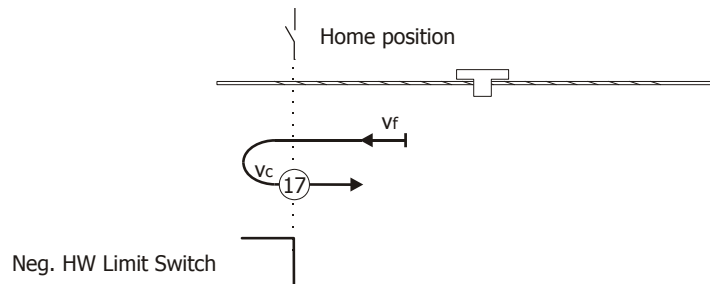

The homing direction (search direction) is negative at *Fast Speed 1132*. When the limit switch is reached, the direction of rotation is reversed and homing is performed at *Creep Speed 1133*.

Home position is the falling edge of the limit switch.

Operation mode 18: Homing to positive HW limit switch without encoder ref. signal.

Dest.:	Positive limit switch	
	Home switch active	
	Search direction	Positive direction
	Speed (before reversal of direction of rotation)	<i>Fast Speed 1132</i>
	Condition reversal of direction of rotation	Rising edge positive limit switch
	Speed (after reversal of direction of rotation)	<i>Creep Speed 1133</i>

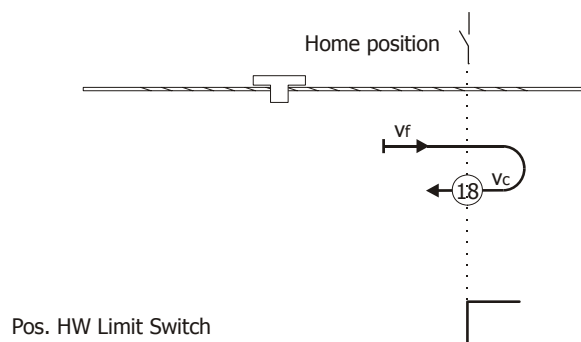

The homing direction (search direction) is positive at *Fast Speed 1132*. When the limit switch is reached, the direction of rotation is reversed and homing is performed at *Creep Speed 1133*.

Home position is the falling edge of the limit switch.

Operation mode 19: Homing to positive home switch without encoder ref. signal., falling edge

Dest.:	Falling left edge of home switch	
A	Home switch active	0
	Search direction	Positive direction
	Speed (before reversal of direction of rotation)	<i>Fast Speed 1132</i>
	Condition reversal of direction of rotation	Rising edge home switch
	Speed (after reversal of direction of rotation)	<i>Creep Speed 1133</i>
B	Home switch active	1
	Search direction	Negative direction
	Speed	<i>Creep Speed 1133</i>

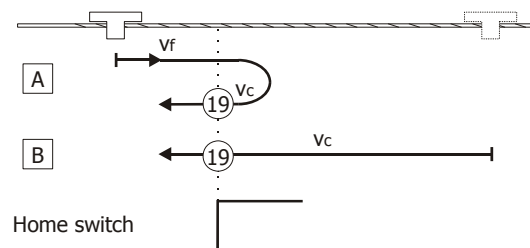

The homing direction (search direction) depends on the signal status of the home switch.

A: Homing direction is positive if the home switch is inactive. Travel to home switch is performed at *Fast Speed 1132*. When the home switch is reached, the direction of rotation is reversed. Home position is the falling edge of the home switch. Search for the home position is performed at *Creep Speed 1133*.

B: Homing direction is negative if the home switch is active. Home position is the falling edge of the home switch. Search for the home position is performed at *Creep Speed 1133*.

Operation mode 20: Homing to positive home switch without encoder ref. signal., rising edge

Dest.:	Rising left edge of home switch	
A	Home switch active	0
	Search direction	Positive direction
	Speed	<i>Fast Speed 1132</i>
B	Home switch active	1
	Search direction	Negative direction
	Speed (before reversal of direction of rotation)	<i>Fast Speed 1132</i>
	Condition reversal of direction of rotation	Falling edge home switch
	Speed (after reversal of direction of rotation)	<i>Creep Speed 1133</i>

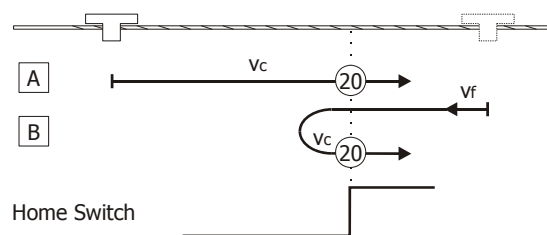

The homing direction (search direction) depends on the signal status of the home switch.

A: Homing direction is positive if the home switch is inactive. Home position is the rising edge of the home switch. Search for the home position is performed at *Creep Speed 1133*.

B: Homing direction is negative if the home switch is active. Travel to falling edge of home switch is performed at *Fast Speed 1132*. When the home switch is passed, the direction of rotation is reversed. Home position is the rising edge of the home switch signal. Search for the home position is performed at *Creep Speed 1133*.

Operation mode 21: Homing to negative home switch without encoder ref. signal., falling edge

Dest.:	Falling right edge of home switch	
A	Home switch active	1
	Search direction	Positive direction
	Speed	<i>Creep speed 1133</i>
B	Home switch active	0
	Search direction	Negative direction
	Speed (before reversal of direction of rotation)	<i>Fast Speed 1132</i>
	Condition reversal of direction of rotation	Rising edge home switch
	Speed (after reversal of direction of rotation)	<i>Creep Speed 1133</i>

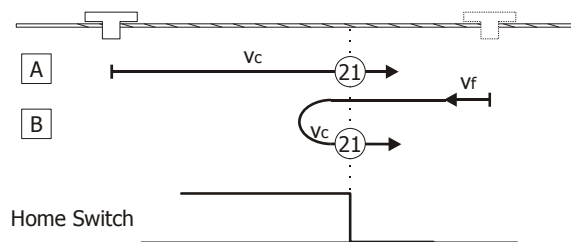

The homing direction (search direction) depends on the signal status of the home switch.

A: Homing direction is positive if the home switch is active. Home position is the falling edge of the home switch. Search for the home position is performed at *Creep Speed 1133*.

B: Homing direction is negative if the home switch is inactive. Travel to rising edge of home switch is performed at *Fast Speed 1132*. When the home switch is passed, the direction of rotation is reversed. Home position is the falling edge of the home switch signal. Search for the home position is performed at *Creep Speed 1133*.

Operation mode 22: Homing to negative home switch without encoder ref. signal., rising edge

Dest.:	Rising right edge of home switch	
A	Home switch active	1
	Search direction	Positive direction
	Speed (before reversal of direction of rotation)	<i>Fast Speed 1132</i>
	Condition reversal of direction of rotation	Falling edge home switch
	Speed (after reversal of direction of rotation)	<i>Creep Speed 1133</i>
B	Home switch active	0
	Search direction	Negative direction
	Speed	<i>Creep Speed 1133</i>

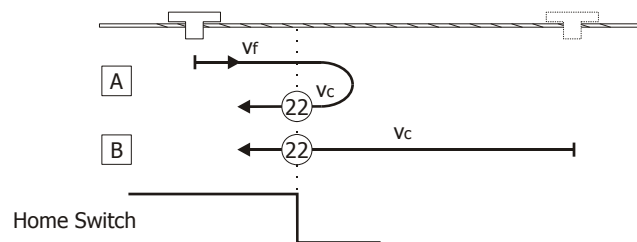

The homing direction (search direction) depends on the signal status of the home switch.

A: Homing direction is positive if the home switch is active. Travel to falling edge of home switch is performed at *Fast Speed 1132*. When the home switch is passed, the direction of rotation is reversed. Home position is the rising edge of the home switch signal. Search for the home position is performed at *Creep Speed 1133*.

B: Homing direction is negative if the home switch is inactive. Home position is the rising edge of the home switch. Search for the home position is performed at *Creep Speed 1133*.

Operation mode 23: Homing to left falling edge of home switch without encoder ref. signal with positive hardware limit switch

Dest.:	Falling left edge of home switch	
A	Home switch active	0
	Search direction	Positive direction
	Speed (before reversal of direction of rotation)	<i>Fast Speed 1132</i>
	Condition reversal of direction of rotation	Rising edge home switch
	Speed (after reversal of direction of rotation)	<i>Creep Speed 1133</i>
B	Home switch active	1
	Search direction	Negative direction
	Speed	<i>Creep Speed 1133</i>
C	Home switch active	0
	Search direction	Positive direction
	Speed (before reversal of direction of rotation)	<i>Fast Speed 1132</i>
	Condition reversal of direction of rotation	Rising edge positive HW limit switch
	Speed (after reversal of direction of rotation)	<i>Fast Speed 1132</i>
	Condition speed change	Rising edge home switch
	Speed (after speed change)	<i>Creep Speed 1133</i>

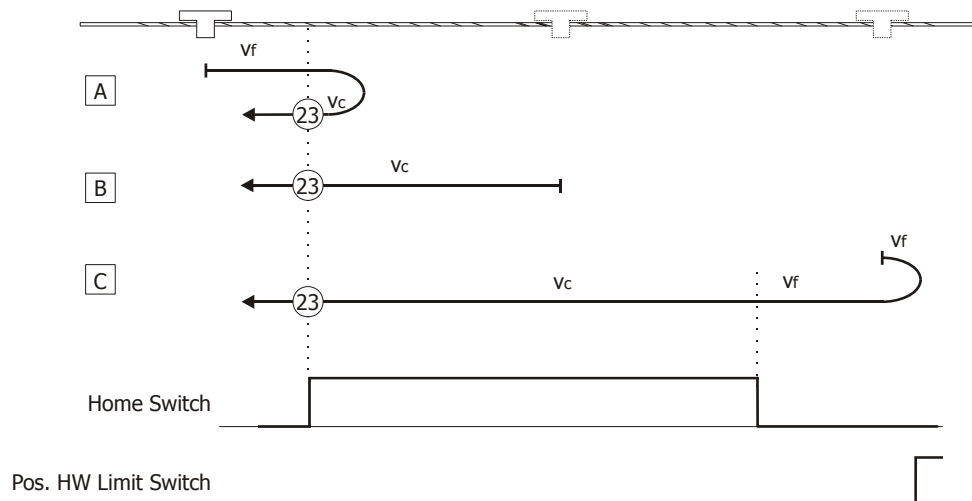

A: Homing direction (search direction) is clockwise toward positive HW limit switch if home switch and limit switch are inactive. The home switch is in search direction. Travel to rising edge of home switch is performed at *Fast Speed 1132*. When the home switch is reached, the direction of rotation is reversed. Home position is the falling edge of the home switch. Search for the home position is performed at *Creep Speed 1133*.

B: When homing is started, the home switch is active. Homing direction (search direction) is anticlockwise toward negative HW limit switch. Home position is the falling edge of the home switch. Search for the home position is performed at *Creep Speed 1133*.

C: Homing direction (search direction) is clockwise toward positive HW limit switch. The home switch is not in search direction. The positive limit switch acts as a reversing switch. When the positive limit switch is reached, the direction of rotation is reversed, and homing is performed in negative direction. Travel to rising (right) edge of home switch signal is performed at *Fast Speed 1132*. Home position is the falling edge of the home switch. Search for the home position is performed at *Creep Speed 1133*.

Operation mode 24: Homing to left rising edge of home switch without encoder ref. signal with positive hardware limit switch

Dest.:	Rising left edge of home switch	
A	Home switch active	0
	Search direction	Positive direction
	Speed	<i>Fast Speed 1132</i>
B	Home switch active	1
	Search direction	Negative direction
	Speed (before reversal of direction of rotation)	<i>Fast Speed 1132</i>
	Condition reversal of direction of rotation	Falling edge home switch
	Speed (after reversal of direction of rotation)	<i>Creep Speed 1133</i>
C	Home switch active	0
	Search direction	Positive direction
	Speed (before reversal of direction of rotation)	<i>Fast Speed 1132</i>
	Condition reversal of direction of rotation	Rising edge positive HW limit switch
	Speed (after reversal of direction of rotation)	<i>Fast Speed 1132</i>
	Condition reversal of direction of rotation	Falling edge home switch
	Speed (after reversal of direction of rotation)	<i>Creep Speed 1133</i>

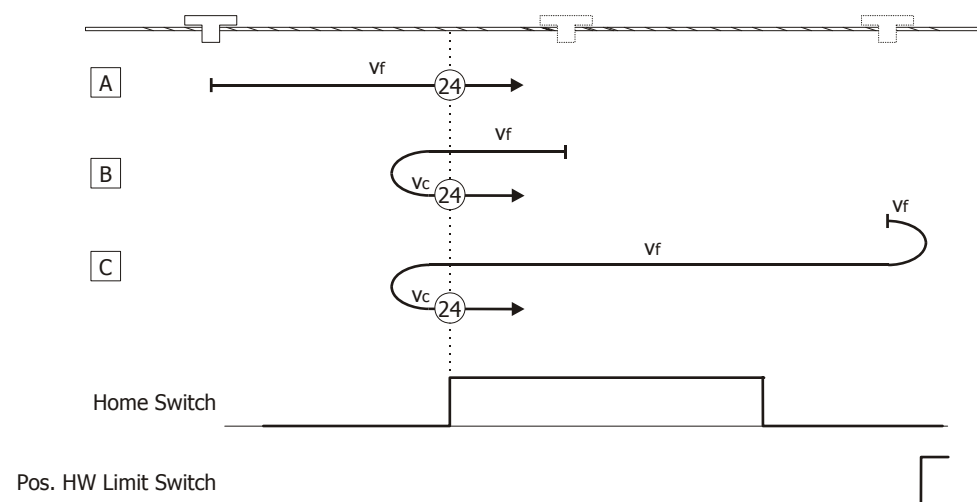

A: Homing direction (search direction) is clockwise toward positive HW limit switch if home switch and limit switch are inactive. The home switch is in search direction. Home position is the rising edge of the home switch. During the whole operation, homing is performed at *Fast Speed 1132*.

B: When homing is started, the home switch is active. Homing direction (search direction) is anticlockwise toward negative HW limit switch. Travel to falling edge of home switch signal is performed at *Fast Speed 1132*. When the home switch is passed in negative direction, the direction of rotation is reversed. Home position is the rising edge of the home switch. Homing is performed at *Creep Speed 1133*.

C: Homing direction (search direction) is clockwise toward positive HW limit switch. The home switch is not in search direction. The positive limit switch acts as a reversing switch. When the positive limit switch is reached, the direction of rotation is reversed, and homing is performed in negative direction. When the home switch is passed, the direction of rotation is reversed again. At first, the operation is performed at *Fast Speed 1132*, when the left edge of the home switch is reached, the speed is changed to *Creep Speed 1133*. Home position is the rising edge of the home switch.

Operation mode 25: Homing to right rising edge of home switch without encoder ref. signal with positive hardware limit switch

Dest.:	Rising right edge of home switch	
A	Home switch active	0
	Search direction	Positive direction
	Speed (before reversal of direction of rotation)	<i>Fast Speed 1132</i>
	Condition reversal of direction of rotation	Falling edge home switch
	Speed (after reversal of direction of rotation)	<i>Creep Speed 1133</i>
B	Home switch active	1
	Search direction	Negative direction
	Speed (before reversal of direction of rotation)	<i>Fast Speed 1132</i>
	Condition reversal of direction of rotation	Falling edge home switch
	Speed (after reversal of direction of rotation)	<i>Creep Speed 1133</i>
C	Home switch active	0
	Search direction	Positive direction
	Speed (before reversal of direction of rotation)	<i>Fast Speed 1132</i>
	Condition reversal of direction of rotation	Rising edge positive HW limit switch
	Speed (after reversal of direction of rotation)	<i>Fast Speed 1132</i>

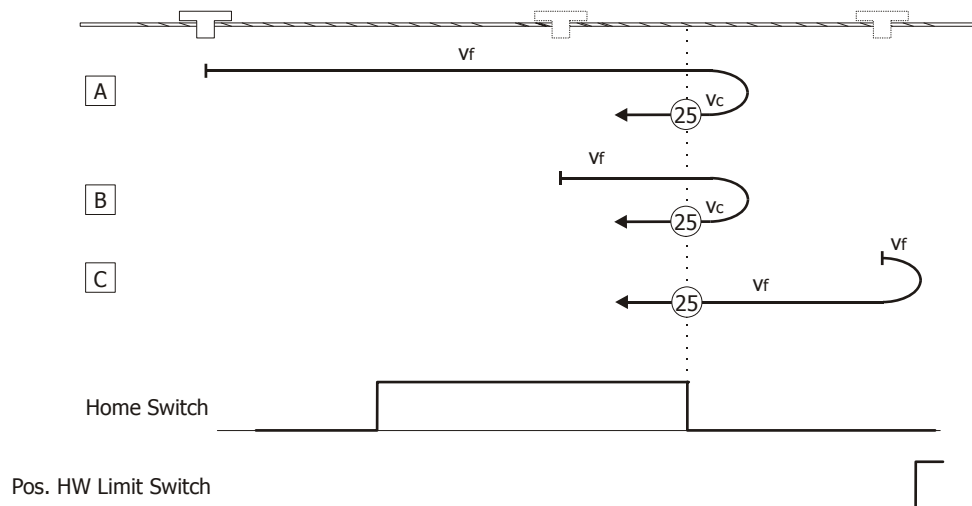

A: Homing direction (search direction) is clockwise toward positive HW limit switch if home switch and limit switch are inactive. The home switch is in search direction. Travel to right edge of home switch is performed at *Fast Speed 1132*. When the home switch is passed, the direction of rotation is reversed. Home position is the rising edge of the home switch signal. Search for the home position is performed at *Creep Speed 1133*.

B: When homing is started, the home switch is active. Homing direction (search direction) is clockwise toward positive HW limit switch. Travel to falling edge of home switch signal is performed at *Fast Speed 1132*. When the home switch is passed in positive direction, the direction of rotation is reversed. Home position is the rising edge of the home switch signal. Homing is performed at *Creep Speed 1133*.

C: Homing direction (search direction) is clockwise toward positive HW limit switch. The home switch is not in search direction. The positive limit switch acts as a reversing switch. When the positive limit switch is reached, the direction of rotation is reversed, and homing is performed in negative direction. Home position is the rising edge of the home switch signal. During the whole operation, homing is performed at *Fast Speed 1132*.

Operation mode 26: Homing to right falling edge of home switch without encoder ref. signal with positive hardware limit switch

Dest.:	Falling right edge of home switch	
A	Home switch active	0
	Search direction	Positive direction
	Speed (before speed change)	<i>Fast Speed 1132</i>
	Condition speed change	Rising edge home switch
	Speed (after speed change)	<i>Creep Speed 1133</i>
B	Home switch active	1
	Search direction	Positive direction
	Speed	<i>Creep Speed 1133</i>
C	Home switch active	0
	Search direction	Positive direction
	Speed (before reversal of direction of rotation)	<i>Fast Speed 1132</i>
	Condition reversal of direction of rotation	Rising edge positive HW limit switch
	Speed (after reversal of direction of rotation)	<i>Fast Speed 1132</i>
	Condition reversal of direction of rotation	Rising edge home switch
	Speed (after reversal of direction of rotation)	<i>Creep Speed 1133</i>

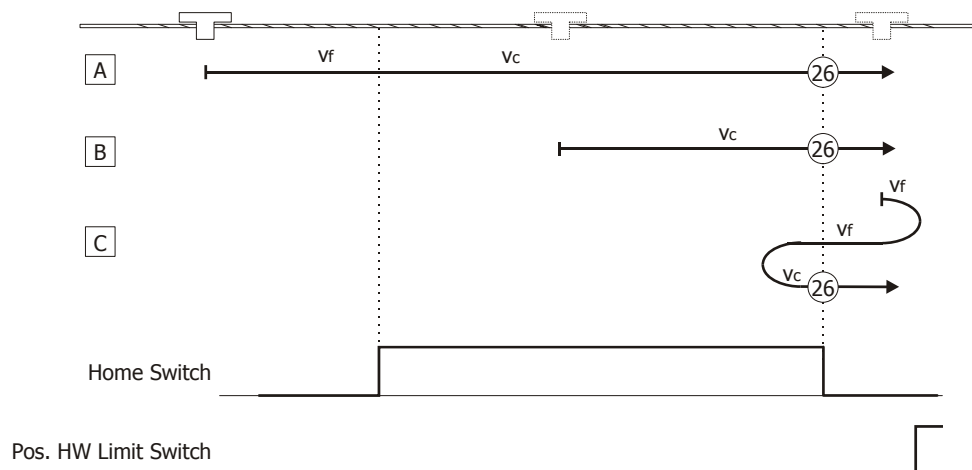

A: Homing direction (search direction) is clockwise toward positive HW limit switch if home switch and limit switch are inactive. The home switch is in search direction. Home position is the falling edge of the home switch. At first, the operation is performed at *Fast Speed 1132*, when the left edge of the home switch is reached, the speed is changed to *Creep Speed 1133*.

B: When homing is started, the home switch is active. Homing direction (search direction) is clockwise toward positive HW limit switch. Home position is the falling edge of the home switch. Homing is performed at *Creep Speed 1133*.

C: Homing direction (search direction) is clockwise toward positive HW limit switch. The home switch is not in search direction. The positive limit switch acts as a reversing switch. When the positive limit switch is reached, the direction of rotation is reversed, and homing is performed in negative direction. When the home switch is reached, the direction of rotation is reversed again. At first, the operation is performed at *Fast Speed 1132*, when the right edge of the home switch is reached, the speed is changed to *Creep Speed 1133*. Home position is the falling edge of the home switch.

Operation mode 27: Homing to right falling edge of home switch without encoder ref. signal with negative hardware limit switch

Dest.:	Falling right edge of home switch	
A	Home switch active	0
	Search direction	Negative direction
	Speed (before reversal of direction of rotation)	<i>Fast Speed 1132</i>
	Condition reversal of direction of rotation	Rising edge home switch
	Speed (after reversal of direction of rotation)	<i>Creep Speed 1133</i>
B	Home switch active	1
	Search direction	Positive direction
	Speed	<i>Creep Speed 1133</i>
C	Home switch active	0
	Search direction	Negative direction
	Speed (before reversal of direction of rotation)	<i>Fast Speed 1132</i>
	Condition reversal of direction of rotation	Rising edge negative HW limit switch
	Speed (after reversal of direction of rotation)	<i>Fast Speed 1132</i>
	Condition speed change	Rising edge home switch
	Speed (after speed change)	<i>Creep Speed 1133</i>

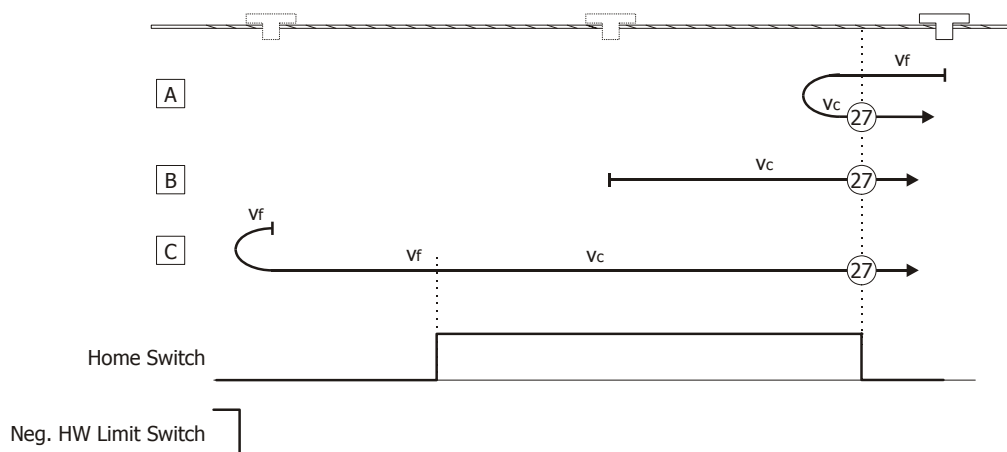

A: Homing direction (search direction) is anticlockwise toward negative HW limit switch if home switch and limit switch are inactive. The home switch is in search direction. Travel to right edge of home switch is performed at *Fast Speed 1132*. When the home switch is reached, the direction of rotation is reversed. Home position is the falling edge of the home switch. Search for the home position is performed at *Creep Speed 1133*.

B: When homing is started, the home switch is active. Homing direction (search direction) is clockwise toward positive HW limit switch. Home position is the falling edge of the home switch. Homing is performed at *Creep Speed 1133*.

C: Homing direction (search direction) is anticlockwise toward negative HW limit switch. The home switch is not in search direction. The negative limit switch acts as a reversing switch. When the negative limit switch is reached, the direction of rotation is reversed, and homing is performed in positive direction. Home position is the falling edge of the home switch. At first, the operation is performed at *Fast Speed 1132*, when the left edge of the home switch is reached, the speed is changed to *Creep Speed 1133*.

Operation mode 28: Homing to right rising edge of home switch without encoder ref. signal with negative hardware limit switch

Dest.:	Rising right edge of home switch	
A	Home switch active	0
	Search direction	Negative direction
	Speed	<i>Fast Speed 1132</i>
B	Home switch active	1
	Search direction	Positive direction
	Speed (before reversal of direction of rotation)	<i>Fast Speed 1132</i>
	Condition reversal of direction of rotation	Falling edge home switch
	Speed (after reversal of direction of rotation)	<i>Creep Speed 1133</i>
C	Home switch active	0
	Search direction	Negative direction
	Speed (before reversal of direction of rotation)	<i>Fast Speed 1132</i>
	Condition reversal of direction of rotation	Rising edge negative HW limit switch
	Speed (after reversal of direction of rotation)	<i>Fast Speed 1132</i>
	Condition reversal of direction of rotation	Rising edge home switch
	Speed (after reversal of direction of rotation)	<i>Creep Speed 1133</i>

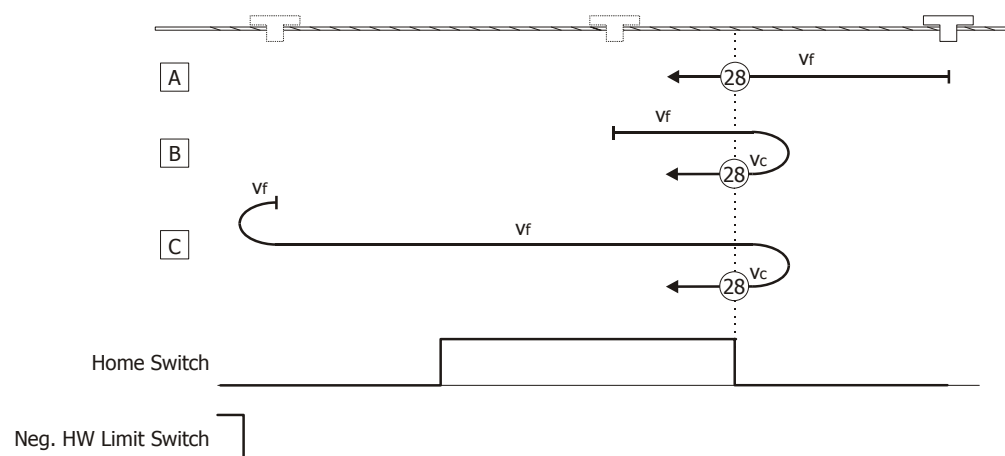

A: Homing direction (search direction) is anticlockwise toward negative HW limit switch if home switch and limit switch are inactive. The home switch is in search direction. Home position is the rising edge of the home switch. Homing is performed at *Fast Speed 1132*.

B: When homing is started, the home switch is active. Homing direction (search direction) is clockwise toward positive HW limit switch. Travel to falling edge of home switch signal is performed at *Fast Speed 1132*. When the home switch is passed in positive direction, the direction of rotation is reversed. Home position is the rising edge of the home switch. Homing is performed at *Creep Speed 1133*.

C: Homing direction (search direction) is anticlockwise toward negative HW limit switch. The home switch is not in search direction. The negative limit switch acts as a reversing switch. When the negative limit switch is reached, the direction of rotation is reversed, and homing is performed in positive direction. When the home switch is passed, the direction of rotation is reversed again. At first, the operation is performed at *Fast Speed 1132*, when the left edge of the home switch is reached, the speed is changed to *Creep Speed 1133*. Home position is the rising edge of the home switch.

Operation mode 29: Homing to left rising edge of home switch without encoder ref. signal with negative hardware limit switch

Dest.:	Rising left edge of home switch	
A	Home switch active	0
	Search direction	Negative direction
	Speed (before reversal of direction of rotation)	<i>Fast Speed 1132</i>
	Condition reversal of direction of rotation	Falling edge home switch
	Speed (after reversal of direction of rotation)	<i>Creep Speed 1133</i>
B	Home switch active	1
	Search direction	Negative direction
	Speed (before reversal of direction of rotation)	<i>Fast Speed 1132</i>
	Condition reversal of direction of rotation	Falling edge home switch
	Speed (after reversal of direction of rotation)	<i>Creep Speed 1133</i>
C	Home switch active	0
	Search direction	Negative direction
	Speed (before reversal of direction of rotation)	<i>Fast Speed 1132</i>
	Condition reversal of direction of rotation	Rising edge negative HW limit switch
	Speed (after reversal of direction of rotation)	<i>Fast Speed 1132</i>

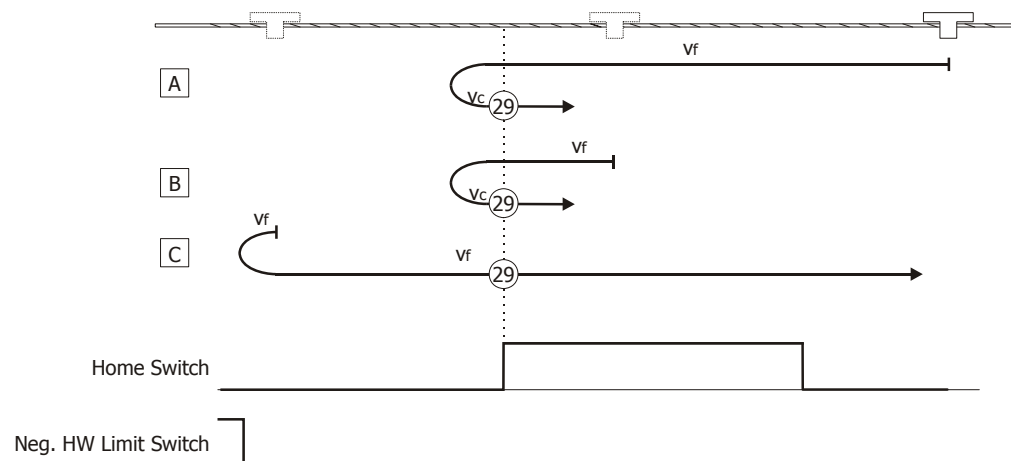

A: Homing direction (search direction) is anticlockwise toward negative HW limit switch if home switch and limit switch are inactive. The home switch is in search direction. Travel to falling edge of home switch is performed at *Fast Speed 1132*. When the home switch is passed, the direction of rotation is reversed. Home position is right of the left edge of the home switch. Search for the home position is performed at *Creep Speed 1133*.

B: When homing is started, the home switch is active. Homing direction (search direction) is anticlockwise toward negative HW limit switch. Travel to falling edge of home switch signal is performed at *Fast Speed 1132*. When the home switch is passed in negative direction, the direction of rotation is reversed. Home position is right of the left edge of the home switch. Search for the home position is performed at *Creep Speed 1133*.

C: Homing direction (search direction) is anticlockwise toward negative HW limit switch. The home switch is not in search direction. The negative limit switch acts as a reversing switch. When the negative limit switch is reached, the direction of rotation is reversed, and homing is performed in positive direction. Home position is right of the left edge of the home switch. During the whole operation, homing is performed at *Fast Speed 1132*.

Operation mode 30: Homing to left falling edge of home switch without encoder ref. signal with negative hardware limit switch

Dest.:	Falling left edge of home switch	
A	Home switch active	0
	Search direction	Negative direction
	Speed (before speed change)	<i>Fast Speed 1132</i>
	Condition speed change	Rising edge home switch
	Speed (after speed change)	<i>Creep Speed 1133</i>
B	Home switch active	1
	Search direction	Negative direction
	Speed	<i>Creep Speed 1133</i>
C	Home switch active	0
	Search direction	Negative direction
	Speed (before reversal of direction of rotation)	<i>Fast Speed 1132</i>
	Condition reversal of direction of rotation	Rising edge negative HW limit switch
	Speed (after reversal of direction of rotation)	<i>Fast Speed 1132</i>
	Condition reversal of direction of rotation	Rising edge home switch
	Speed (after reversal of direction of rotation)	<i>Creep Speed 1133</i>

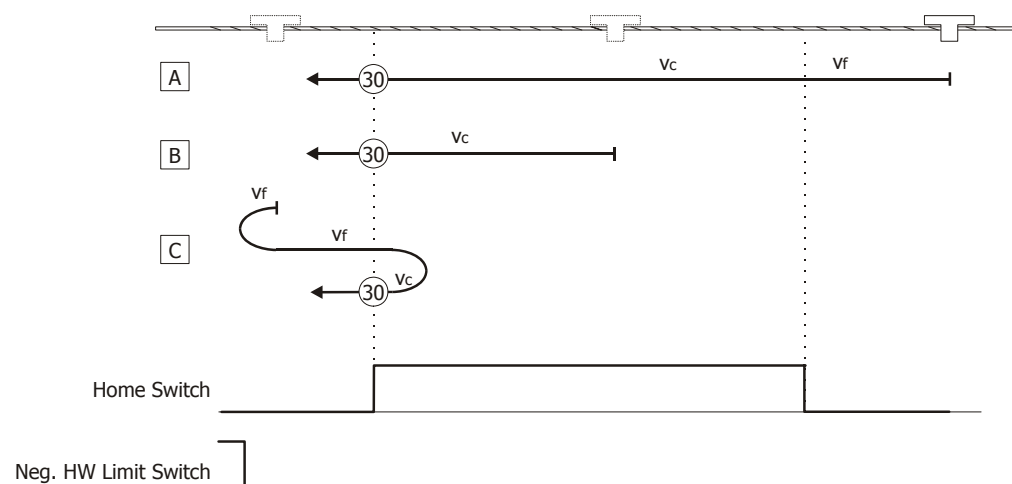

A: Homing direction (search direction) is anticlockwise toward negative HW limit switch if home switch and limit switch are inactive. The home switch is in search direction. Home position is left of the left edge of the home switch. Travel to rising (right) edge of home switch is performed at *Fast Speed 1132*. Search for the home position is performed at *Creep Speed 1133*.

B: When homing is started, the home switch is active. Homing direction (search direction) is anticlockwise toward negative HW limit switch. Home position is left of the left edge of the home switch. Search for the home position is performed at *Creep Speed 1133*.

C: Homing direction (search direction) is anticlockwise toward negative HW limit switch. The home switch is not in search direction. The negative limit switch acts as a reversing switch. When the negative limit switch is reached, the direction of rotation is reversed, and homing is performed in positive direction. When the home switch is reached, the direction of rotation is reversed again. Home position is left of the left edge of the home switch. Travel to rising (left) edge of home switch is performed at *Fast Speed 1132*. Search for the home position is performed at *Creep Speed 1133*.

5.5.3 Homing modes, only ref. signal and actual position

Operation modes 33 and 34: Homing to first encoder ref. signal

Home position is the first encoder ref. signal in negative (operation mode 33) or positive (operation mode 34) direction.

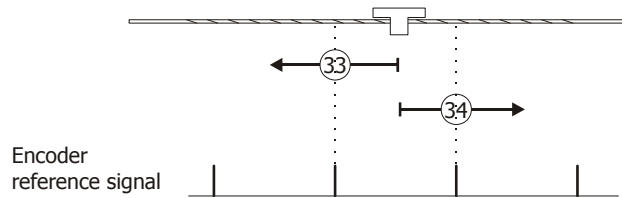

Operation mode 35: Current position is home position

Current position is home position. Home offset (Parameter 1131) is taken over as actual position value.

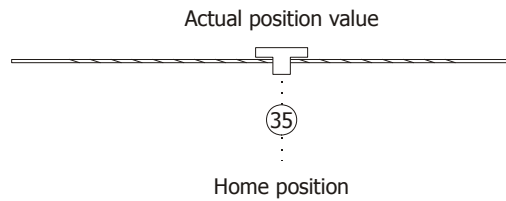

Note: Without encoder ref. signal, homing modes 1 to 14 as well as 33 and 34 are not possible.

6 Output Signals and fault messages

6.1 Actual positioning values

The display of actual values in VPlus is refreshed after the window for parameterizing of motion blocks VTable has been closed.

Note: For information on other actual values, refer to the operating instructions of the frequency inverter.

Application Warnings 273

shows warning messages affecting the positioning functions.

Actual Appl. Warning Mask 627

shows current warning mask.

Act. Speed 1107

shows current speed in unit [u/s].

Act. Position 1108

shows the current position in unit [u].

Act. Contouring Error 1109

shows the current contouring error in unit [u].

Peak Value Contouring Error 1121

The contouring error peak value can be monitored in the actual value memory. With parametersetting *Reset Memory 237* = "18 - Peak Value Contouring Error", you can reset the saved value.

Act. Master Speed 1129

shows the speed of the master on the output of the electronic gear in the operation modes with electronic gear (*Motion Mode 1208*).

Actual Motion Block 1246

shows the motion block currently processed.
Value -10 indicates a homing.

Motion Block to Resume 1249

shows the motion block which was interrupted after an error message or by reset of the "Start Positioning" signal and can then be resumed.
Parameter value is "-1" when the resume function is disabled. Resume function is disabled in teach-in mode or if *Homing Mode 1130* is set to "0 – No Homing Done".

6.2 Status word of the positioning

The positioning offers advanced information via a positioning status word. This status word is output during operation by parameter *Actual Motion Mode* **1255**.

Additional the same information is available for other device functions (system bus, scope) via the signal source "880 - Actual Motion Mode".

Actual Motion Mode **1255**

The decimal value with text shows:

- if a homing operation is started
- if a positioning operation is started
- the motion mode of the actual motion block
- the operation mode "Teach-In" of the control
- the JOG-Mode

The displayed decimal value can be converted into binary representation. The resultant bits of the status word indicate the active motion mode.

Decimal	Bit-No.	Is set in Motion Mode or Operation Mode
0	0	JOG-Mode. JOG-Mode is enabled via parameter <i>Jog-Mode Active</i> 1231 .
2	1	Homing is started: <ul style="list-style-type: none"> - Manually via parameter <i>Start Homing (manual)</i> 1235 in <i>Operation Mode</i> 1220 = "1 - manual" or - Automatically via controller release and signal at <i>Start Positioning</i> 1222 in <i>Operation Mode</i> 1220 = "2 - automatic".
4	2	Teach-In. Parameter <i>Operation Mode</i> 1221 is set to: <ul style="list-style-type: none"> - "301 - Teach-In, Motion Block Sel. via Digital Inputs" or - "302 - Teach-In, Motion Block Sel. via P. 1228"
8	3	Positioning operation is started.
16	4	Absolute. Parameter <i>Motion Mode</i> 1208 of the actual motion block is set to "0 - absolute".
32	5	Relative. Parameter <i>Motion Mode</i> 1208 of the actual motion block is set to "1 - relative".
64	6	Touch-Probe. Parameter <i>Motion Mode</i> 1208 of the actual motion block is set to: <ul style="list-style-type: none"> - "2 - Touch-Probe: Rising Edge" or - "3 - Touch-Probe: Falling Edge" or - "12 - gearing, Touch-Probe: Rising Edge" or - "13 - gearing, Touch-Probe: Falling Edge" or - "22 - gearing, direct sync., Touch-Probe: Rising Edge" or - "23 - gearing, direct sync., Touch-Probe: Falling Edge"
128	7	Velocity. Parameter <i>Motion Mode</i> 1208 of the actual motion block is set to "4 - Velocity".

Decimal	Bit-No.	Is set in Motion Mode or Operation Mode
256	8	Gearing. Parameter <i>Motion Mode 1208</i> of the actual motion block is set to: <ul style="list-style-type: none"> - "10 - gearing, absolute" or - "11 - gearing, relative" or - "12 - gearing, Touch-Probe: Rising Edge" or - "13 - gearing, Touch-Probe: Falling Edge" or - "14 - gearing" or - "20 - gearing, direct sync., absolute" or - "21 - gearing, direct sync., relative" or - "22 - gearing, direct sync., Touch-Probe: Rising Edge" or - "23 - gearing, direct sync., Touch-Probe: Falling Edge" or - "24 - gearing, direct synchronization"
512	9 ... 15	The bit will not be set. No function assigned.

Example:

Value 328 decimal is displayed in parameter *Actual Motion Mode 1255*.

Status word after conversion from 328 decimal to binary representation:

0 | 0 | 0 | 0 | 0 | 0 | 0 | 1 | 0 | 1 | 0 | 0 | 1 | 0 | 0 | 0

Bit-Numbers of the status word:

15 | 14 | 13 | 12 | 11 | 10 | 9 | 8 | 7 | 6 | 5 | 4 | 3 | 2 | 1 | 0

Meaning: Active is a positioning (bit 3) in Motion Mode "gearing (bit 8), Touch-Probe (bit 6)".

Note: The status word can be transmitted as signal source "880 - Actual Motion Mode" via system bus. This requires an expansion module with system bus interface.

6.3 Status word 411

Parameter *Status word 411* includes two specific bits of the positioning. These bits can be evaluated by the logic control.

Note: The applicable status word is dependent on the operation mode *Local/Remote 412*. The status word is used in most of the operation modes for parameter *Local/Remote 412*.

If the inverter is controlled via statemachine (*Local/Remote 412* = „1 - Control via Statemachine“) a different status word is applicable. Refer to the operating instructions of the communication modules or expansion modules.

<i>Statusword 411</i>	
Bit-No.	Function
0	Ready for being switched on
1	Switched on
2	Operation – released
3	Error
4	Voltage – disabled
5	Quick Stop
6	Starting lock-out
7	Warning
8	Homing Done
9	Remote
10	Reference value reached
11	Limit value reached
12	-
13	-
14	Target Position Reached
15	Warning 2

8 Homing Done.
Homing is carried out successfully. The home position is set. This bit stays set until homing is restarted.
The bit is only output in the settings of parameter *Local/Remote 412* ≠ „1 - Control via Statemachine“.

14 Target Position Reached.
Target Position/Distance 1202 of a positioning operation was reached, and current actual position is within the range set in parameter *Target window 1165* for a minimum period of *Target window time 1166*.
The bit is only output in the settings of parameter *Local/Remote 412* ≠ „1 - Control via Statemachine“.
The bit is reset if:

- The drive travels out of the range set in parameter *Target window 1165* or
- JOG-Mode is enabled or
- Homing is started or
- Operation mode “Teach-In” is enabled

6.4 Digital Positioning Output Signals

Parameters *OP. Mode Digital Output 1* **530** of digital output S1OUTD and *Op. Mode Digital Output 3* **532** of the relay output link the digital outputs to various functions.

The use of the multifunctional output MFO1 as a digital output requires parameter-setting *Operation mode* **550** = "1 - Digital" and linking via parameter *Digital operation MFO1* **554**.

The following output signals of the positioning function can be assigned to the digital outputs. For information on other operation modes, refer to the operating instructions of the frequency inverter.

Digital signals	Function
26 - Warning, Application	Warning messages of error/warning behavior function (HW limit switches, SW limit switches and contouring error monitoring of positioning function). The warnings are displayed as actual values via parameter <i>Application Warnings</i> 273 .
27 - Warning Mask, Application	Message of the configurable parameter <i>Create Warning Mask Application</i> 626 .
56 - Phasing Done	Master position evaluated by slave was offset by value of parameter <i>Phasing: Offset</i> 1125 .
57 - In Gear	In <i>Motion Mode</i> 1208 with electronic gear (operation modes 10 to 14), synchronous operation of electronic gear was reached. Slave drive is engaged at current position and operates at a synchronous angle with master. Slave drive is synchronized with master frequency.
58 - Position Comparator	Current position value is in the range between <i>On-Position</i> 1243 and <i>Off-Position</i> 1244 . The value selected in parameter <i>Hysteresis</i> 1245 is considered.
59 - Homing Done	Message is triggered by homing operation or in <i>Motion Mode</i> 1208 with touch probe by taking over current position as reference position.
60 - Target Position Reached	<i>Target Position / Distance</i> 1202 of a positioning operation was reached, and current act. position is within the range set in parameter <i>Target window</i> 1165 for a minimum period of <i>Target window time</i> 1166 .
61 - Warning Deviation of Position	The contouring error monitoring <i>Warning Threshold</i> 1105 was exceeded.
62 - Motion-Block Digital Signal 1	Message on status of a travel order during a positioning operation. The conditions set for parameter <i>Digital Signal 1</i> 1218 were fulfilled.
63 - Motion-Block Digital Signal 2	Message on status of a travel order during a positioning operation. The conditions set for parameter <i>Digital Signal 2</i> 1219 were fulfilled.
64 - Motion-Block Digital Signal 3	Message on status of a travel order during a positioning operation. The conditions set for parameter <i>Digital Signal 3</i> 1247 were fulfilled.
65 - Motion-Block Digital Signal 4	Message on status of a travel order during a positioning operation. The conditions set for parameter <i>Digital Signal 4</i> 1248 were fulfilled.
126-165	Operation modes 26 to 65, inverted.

6.5 Logic Signal Sources for Positioning

Logic signal sources can be assigned to the software functions for further processing. In addition to the signals on the digital control inputs, the following signal sources of the positioning functions are available. For information on other signal sources, refer to the operating instructions of the frequency inverter.

Logic signal	Function
215 - Warning Mask, Application	Message of the configurable parameter <i>Create Warning Mask Application</i> 626 .
216 - Application Warning	Warning messages of error/warning behavior function (HW limit switches, SW limit switches and contouring error monitoring of positioning function). The warnings are displayed as actual values via parameter <i>Application Warnings</i> 273 .
282 - Target Position Reached	<i>Target Position / Distance</i> 1202 of a positioning operation was reached, and current position is within the range set in parameter <i>Target window</i> 1165 for a minimum period of <i>Target window time</i> 1166 .
604 - Warning Position Controller	The contouring error monitoring <i>Warning Threshold</i> 1105 was exceeded.
614 - Homing Done	Reference position is set. This is done by homing (parameters 1220 and 1130 to 1135) or in <i>Motion Mode</i> 1208 with touch probe (operation modes 2, 3, 12, 13) by taking over current position as reference position
615 - Homing Requested	A homing operation was started. The signal is reset at the end of the homing operation.
616 - Phasing Done	Master position evaluated by slave was offset by value of parameter <i>Phasing: Offset</i> 1125 . Parameters of phasing function are available in master settings of positioning function.
617 - Latched Position	The stored actual position value of the drive. With a rising or falling signal edge (according to <i>Operation Mode</i> 1280) at digital input S2IND the actual position value is stored in the EEPROM. The value is displayed via parameter <i>Latched Position</i> 1281 .
624 - In Gear	In <i>Motion Mode</i> 1208 with electronic gear (operation modes 10 to 14), synchronous operation of electronic gear was reached. Slave drive is engaged at current position and operates at a synchronous angle with master. Slave drive is synchronized with master frequency.
876 - Position Comparator Out	Current position value is in the range between <i>On-Position</i> 1243 and <i>Off-Position</i> 1244 . The value selected in parameter <i>Hysteresis</i> 1245 is considered.
877 - Position Comparator Out inverted	Logic signal 876 inverted.
887 - MBC: Start Clockwise	Status message of clockwise operation of positioning control.
888 - MBC: Start Anticlockwise	Status message of anticlockwise operation of positioning control.

Logic signal	Function
891 - Motion-Block Digital Signal 1	Message on status of a travel order during a positioning operation. The conditions set for parameter <i>Digital Signal 1</i> 1218 were fulfilled.
892 - Motion-Block Digital Signal 2	Message on status of a travel order during a positioning operation. The conditions set for parameter <i>Digital Signal 2</i> 1219 were fulfilled.
893 - Motion-Block Digital Signal 3	Message on status of a travel order during a positioning operation. The conditions set for parameter <i>Digital Signal 3</i> 1247 were fulfilled.
894 - Motion-Block Digital Signal 4	Message on status of a travel order during a positioning operation. The conditions set for parameter <i>Digital Signal 4</i> 1248 were fulfilled.
895 - Motion-Block Digital Signal 1 inverted	Logic signal 891 inverted.
896 - Motion-Block Digital Signal 2 inverted	Logic signal 892 inverted.
897 - Motion-Block Digital Signal 3 inverted	Logic signal 893 inverted.
898 - Motion-Block Digital Signal 4 inverted	Logic signal 894 inverted.

6.6 Positioning Error Messages

The following error messages may occur during positioning operations. For information on other error messages, refer to the operating instructions of the frequency inverter.

Error	Error message	Description/Action
F0404	Control Deviation Position Controller	The current contouring error has exceeded the value defined in <i>Error Threshold 1106</i> for a time longer than the time defined in parameter <i>Contouring Error Time 1119</i> . Optimize settings for speed (parameters 419, 1203, 1236) and acceleration pilot control (parameters 725 to 727)
F1442	Pos. SW-Limit Switch	Current position or target position of current motion order exceeds value for parameter <i>Positive SW Limit Switch 1145</i> . Check <i>Target Position / Distance 1202</i> parameter values entered in motion blocks.
F1443	Neg. SW-Limit Switch	Current position or target position of current motion order exceeds value for parameter <i>Negative SW Limit Switch 1146</i> . Check <i>Target Position / Distance 1202</i> values entered in motion blocks.
F1444	Pos. SW-Lim. Switch < Neg. SW-Lim. Switch	Value of parameter <i>Positive SW Limit Switch 1145</i> smaller than value of parameter <i>Negative SW Limit Switch 1146</i> . Check and, if necessary, change parameter values.
F1445	Pos. and Neg. HW-Lim Switch Simultaneously	Both hardware limit switches are active at the same time. Check limit switches and wiring of application.
F1446	Limit Switch Incorrect Wired!	Positive hardware limit switch activated although positioning performed in negative direction (motor rotates anticlockwise). Or: Negative hardware limit switch activated although positioning performed in positioning direction (motor rotates clockwise). Check plant and wiring.
F1447	Pos. HW Limit Switch	The positive hardware limit switch was reached. Check <i>Target Position / Distance 1202</i> values entered in motion blocks.
F1448	Neg. HW Limit Switch	The negative hardware limit switch was reached. Check <i>Target Position / Distance 1202</i> values entered in motion blocks.
F1451	Clockwise Operation Locked	Positive hardware limit switch or positive software limit switch reached. After acknowledgement of error it was tried to move in positive direction (clockwise). Positive direction is disabled as long as positive limit switch is active. Move axis in defined travel range again: In JOG mode, move in opposite direction or start positioning in opposite direction.

Error	Error message	Description/Action
F1452	Anti-Clockwise Operation Locked	Negative hardware limit switch or negative software limit switch reached. After acknowledgement of error it was tried to move in negative direction (anticlockwise). Negative direction is disabled as long as negative limit switch is active. Move axis in defined travel range again: In JOG mode, move in opposite direction or start positioning in opposite direction.
F1453	System bus-Synchronization not activated	Parameter <i>Master Position Source 1122</i> of electronic gear is set to operation mode "11 - RxPDO1.Long1 extrapolated", but frequency inverter is not synchronized with data telegrams of system bus. Switch on system bus synchronization: Set Parameter <i>Operation Mode 1180</i> to "1 - RxPDO1" or "10 - SYNC" (chapter "Master position source").
F1460	Pos. HW-Lim. Switch: Illegal Signal Source	<i>Pos. HW Limit Switch 1138</i> is set to an illegal logic signal source or to a digital input of an expansion module (EM-S1IND, EM-S2IND or EM-S3IND) although no expansion module is installed. The parameter must be set to an available digital input.
F1461	Pos. HW-Lim. Switch: Input disabled by PWM-/FF-Input	The digital input for <i>Pos. HW Limit Switch 1138</i> is set as PWM- or repetition frequency input. Set parameter <i>Operation Mode 496</i> of the PWM-/repetition frequency input to "0 - off" or to another digital input to use the digital input as HW-limit switch input.
F1462	Pos. HW-Lim. Switch: Input disabled by Index-Contr.	The digital input for <i>Pos. HW Limit Switch 1138</i> is set as input for index control. Check the settings of <i>Operation Mode 598</i> of the index control and <i>Index Controller Release 96</i> . Alternatively use another digital input for the connection of the HW-limit switch.
F1463	Pos. HW-Lim. Switch: Wrong Op.-Mode for MFI1	The multifunction input MFI1 at terminal X210B.6 is set as voltage input or current input via parameter <i>Operation Mode 452</i> . Set <i>Operation Mode 452</i> to "3 - Digital Input" to use the multifunction input as HW-limit switch input.
F1464	Pos. HW-Lim. Switch: Input disabled by Encoder 1	The digital input for <i>Pos. HW Limit Switch 1138</i> is set as encoder input. Set <i>Operation Mode 490</i> of the speed sensor 1 to "0 - off" to use the digital input as HW-limit switch input. Alternatively use another digital input for the connection of the HW-limit switch.
F1465	Pos. HW-Lim. Switch: Input disabled by Encoder 2	The digital input for <i>Pos. HW Limit Switch 1138</i> is set as encoder input. Set <i>Operation Mode 493</i> of the speed sensor 2 to "0 - off" to use the digital input as HW-limit switch input. Alternatively use another digital input for the connection of the HW-limit switch.
F1466	Pos. HW-Lim. Switch: Wrong Op.-Mode for EM-S1IOD	The digital port EM-S1IOD of an expansion module is misadjusted for the evaluation of a HW-limit switch. The parameter <i>Operation Mode 558</i> must be set to "0 - input".

Error	Error message	Description/Action		
F1470	Neg. HW-Lim. Switch: Illegal Signal Source	<i>Neg. HW Limit Switch 1137</i> is set to an illegal logic signal source or to a digital input of an expansion module (EM-S1IND, EM-S2IND or EM-S3IND) although no expansion module is installed. The parameter must be set to an available digital input.		
F1471	Neg. HW-Lim. Switch: Input disabled by PWM-/FF-Input	The digital input for <i>Neg. HW Limit Switch 1137</i> is set as PWM- or repetition frequency input. Set parameter <i>Operation Mode 496</i> of the PWM-/repetition frequency input to "0 - off" or to another digital input to use the digital input as HW-limit switch input.		
F1472	Neg. HW-Lim. Switch: Input disabled by Index-Contr.	The digital input for <i>Neg. HW Limit Switch 1137</i> is set as input for index control. Check the settings of <i>Operation Mode 598</i> of the index control and <i>Index Controller Release 96</i> . Alternatively use another digital input for the connection of the HW-limit switch.		
F1473	Neg. HW-Lim. Switch: Wrong Op.-Mode for MFI1	The multifunction input MFI1 at terminal X210B.6 is set as voltage input or current input via parameter <i>Operation Mode 452</i> . Set <i>Operation Mode 452</i> to "3 - Digital Input" to use the multifunction input as HW-limit switch input.		
F1474	Neg. HW-Lim. Switch: Input disabled by Encoder 1	The digital input for <i>Neg. HW Limit Switch 1137</i> is set as encoder input. Set <i>Operation Mode 490</i> of the speed sensor 1 to "0 - off" to use the digital input as HW-limit switch input. Alternatively use another digital input for the connection of the HW-limit switch.		
F1475	Neg. HW-Lim. Switch: Input disabled by Encoder 2	The digital input for <i>Neg. HW Limit Switch 1137</i> is set as encoder input. Set <i>Operation Mode 493</i> of the speed sensor 2 to "0 - off" to use the digital input as HW-limit switch input. Alternatively use another digital input for the connection of the HW-limit switch.		
F1476	Neg. HW-Lim. Switch: Wrong Op.-Mode for EM-S1IOD	The digital port EM-S1IOD of an expansion module is misadjusted for the evaluation of a HW-limit switch. The parameter <i>Operation Mode 558</i> must be set to "0 - input".		
F15xx	User-Defined Error in Motion Block xx (1 ≤ xx ≤ 32)	<p>The parameterized behavior for Delay or "Next Motion Block" (after event) is effective.</p> <ul style="list-style-type: none"> – A delay is expired or an event is triggered and – one of the following operation modes is assigned to a parameter for "Next Motion Block" <p>Parameter for "Next Motion Block":</p> <table border="0" style="width: 100%;"> <tr> <td style="width: 60%; vertical-align: top;"> <i>Delay: Next Motion Block 1213,</i> <i>Event 1: Next Motion Block 1215,</i> <i>Event 2: Next Motion Block 1217,</i> <i>Int.-Event 1: Next Motion Block 1262,</i> <i>Int.-Event 2: Next Motion Block 1265</i> </td> <td style="width: 40%; vertical-align: top;"> Operation Mode: -1 (Minus 1) – Error Switch-Off -2 (Minus 2) – Stop, error -3 (Minus 3) – Em. stop, error </td> </tr> </table>	<i>Delay: Next Motion Block 1213,</i> <i>Event 1: Next Motion Block 1215,</i> <i>Event 2: Next Motion Block 1217,</i> <i>Int.-Event 1: Next Motion Block 1262,</i> <i>Int.-Event 2: Next Motion Block 1265</i>	Operation Mode: -1 (Minus 1) – Error Switch-Off -2 (Minus 2) – Stop, error -3 (Minus 3) – Em. stop, error
<i>Delay: Next Motion Block 1213,</i> <i>Event 1: Next Motion Block 1215,</i> <i>Event 2: Next Motion Block 1217,</i> <i>Int.-Event 1: Next Motion Block 1262,</i> <i>Int.-Event 2: Next Motion Block 1265</i>	Operation Mode: -1 (Minus 1) – Error Switch-Off -2 (Minus 2) – Stop, error -3 (Minus 3) – Em. stop, error			
F1570	No Homing Done	Positioning was started without prior homing. Signal "59 – Homing Done" is not set and there is no point of reference for positioning. Start homing. Before starting positioning, wait until signal "59 – Homing Done" is set.		

Error	Error message	Description/Action
F1571	Homing : Encoder-Mode w.o. Z-Impulse	For <i>Homing Mode 1130</i> , an operation mode with zero impulse was selected for setting the reference position. However, an operation mode without zero impulse is selected to evaluate the encoder.
F1572	Both Directions Locked	Settings of SW limit switches or connections of HW limit switches is not correct. Check parameter configuration, particularly settings of parameters <i>Positive SW Limit Switch 1145</i> and <i>Negative SW Limit Switch 1146</i> . Check limit switches and wiring of application. Switch frequency inverter off and on again to reset this error.
F1573	No Touch Probe Signal Detected	No touch-probe signal received within the range set in parameter <i>Touch-Probe-Window 1209</i> . Check position and wiring of touch probe sensor. Touch probe sensor must be connected on digital input S3IND. If necessary, increase touch probe window.

The display of actual values in VPlus is refreshed after the window for parameterizing of motion blocks VTable has been closed.

6.7 Positioning Warning Status

Warnings of the positioning functions are displayed in the error environment by parameter *Application Warning Status* **367** and can be used for an early message of a critical operational condition. Combinations of various warnings can be created in parameter *Create Appl. Warning Mask* **626**. If a warning is present, this is indicated by the flashing red LED and the display field WARN of the control unit KP500.

Meaning of code displayed by parameter *Application Warning Status* **367**:

Code	Warning status
A 0000 NO WARNING	No warning message present.
A 0002 SW-LIM CW	The positive SW limit switch was reached during clockwise operation of the motor (parameter <i>Positive SW limit switch</i> 1145).
A 0004 SW-LIM CCW	The negative SW limit switch was reached during anti-clockwise operation of the motor (parameter <i>Negative SW limit switch</i> 1146).
A 0008 HW-LIM CW	The positive HW limit switch was reached during clockwise operation of the motor (parameter <i>Positive HW limit switch</i> 1138).
A 0010 HW-LIM CCW	The negative HW limit switch was reached during anti-clockwise operation of the motor (parameter <i>Negative HW limit switch</i> 1137).
A 0020 CONT	The contouring error monitoring range adjusted with parameter <i>Warning Threshold</i> 1105 was left.

6.8 Diagnosis and fault clearance

Diagnosis and monitoring in operation and in the case of error messages is represented clearly by parameter groups "Actual Values of Frequency Inverter" and "Actual Values of Machine". In these parameter groups, the operating status and values can be analyzed.

For the error messages of parameter *Current Error* **259**, refer to section "Positioning Error Messages" of positioning function.

In the case of an error message, always perform the following steps:

- Check wiring and units for damage.
- Check if all units (including bus clients, encoders, etc.) are supplied with power and ready for operation.
- If a limit switch is active, the corresponding direction of rotation is disabled. First, the drive must be moved into the permissible range in opposite direction (e.g. in JOG mode).
- Check if homing was completed and "614 – Homing Done" was signaled.

The positioning functionality is very complex. Due to this complexity in combination with other devices (e.g. PLC), diagnosis must generally be performed across the whole system.

The following descriptions of anomalous operating behaviours help to find the cause of failures.

6.8.1 Touch probe: Drive is decelerated or stops

Description:

Touch probe input is used in parameterization. As soon as the touch probe input is activated, the drive is decelerated or stopped.

Remedy:

Change parameter *Stop Positioning* **1223** to an input other than S3IND. Change wiring accordingly.

6.8.2 Drive jerks/is very load

Description:





Drive jerking during positioning and is very loud.

Remedy:

If the resolution is too coarse, the number of increments (units) per revolution is too low which results in inexact positioning. Increase precision in application via *Feed Constant* **1115** (factor 100 or 1000 typical). Change positioning data in motion blocks, too. Then perform homing operation. Software limit switches must be adjusted to new environment, too.

7 Parameter List

The parameter list is ordered numerically. For better clarity, the parameters are marked with pictograms.

-  The parameter is available in the four data sets.
-  Parameter value is displayed in VSetup
-  This parameter cannot be written when the frequency inverter is in operation.
-  This parameter can be edited using VTable in VPlus.



Note: At the control unit KP500 parameter numbers > 999 are displayed hexadecimal at the leading digit (999, A00 ... B5 ... C66).

7.1 Actual Value Menu (VAL)

Actual Values of the Frequency Inverter				
No.	Description	Unit	Display range	Chapter
273	Application Warnings	-	A0000 ... A003F	6.1; 4.8.6
Error Environment				
367	Application Warning Status	-	A0000 ... A003F	6.7; 4.8.6
Digital Outputs				
627	Actual Appl. Warning Mask	-	A0000 ... A003F	6.1; 4.8.6
Actual Values of the Machine				
1107	Act. Speed	u/s	$-2^{31} \dots 2^{31}-1$	6.1
1108	Act. Position	u	$-2^{31} \dots 2^{31}-1$	6.1
1109	Act. Contouring Error	u	$0 \dots 2^{31}-1$	6.1; 4.8.5
Actual value memory				
1121	Peak Value Contouring Error	u	$0 \dots 2^{31}-1$	6.1; 4.8.5
Actual Values of the Machine				
1129	Act. Master Speed	u/s	$-2^{31} \dots 2^{31}-1$	6.1; 4.4.1.5
1246	Actual Motion Block	-	$-10^1, -3 \dots 32$	6.1; 4.4.2.4
1249	Motion Block to Resume	-	$-1 \dots 32$	6.1; 4.4.5.2
Actual Values of the Machine				
1255	Actual Motion Mode	-	Status word decimal code & text	6.1
Latching function				
1281	Latched Position	u	$-2^{31} \dots 2^{31}$	4.13

¹⁾ -10: Homing

7.2 Parameter Menu (PARA)

Warning application						
No.	Description	Unit	Setting range	Fact. sett.	Chapter	
626	Create Appl. Warning Mask	-	Selection: 0 ... 115	0 – no change	4.8.6	
Position Controller						
	1104	Time Constant	ms	0.00 ... 300.00	10.00 ¹⁾ 100.00 ²⁾	4.12
Contouring Error Monitoring						
	1105	Warning Threshold	u	$0 \dots 2^{31}-1$	32768	4.8.5
	1106	Error Threshold	u	$0 \dots 2^{31}-1$	65536	4.8.5

¹⁾ For parameter setting *Configuration 30* = 240 or 540

²⁾ For parameter setting *Configuration 30* = 440

Reference System						
No.	Description	Unit	Setting range	Fact. sett.	Chapter	
✓⊗	1115	Feed Constant	u/U	1 ... $2^{31}-1$	2^{16}	3.5.2
✓⊗	1116	Gear Box: Driving shaft revolutions	-	1 ... 65535	1	3.5.2
✓⊗	1117	Gear Box: Motor shaft revolutions	-	1 ... 65535	1	3.5.2
Position Controller						
☐	1118	Limitation	u/s	0 ... $2^{31}-1$	327680	4.12
Contouring error supervision						
☐	1119	Contouring Error Time	ms	0 ... 65535	10	4.8.5
☐	1120	Fault Reaction	-	Selection: 0 ... 3	0 – Off	4.8.5
Master Settings (el. gear)						
☐	1122	Master Position Source	-	0 ... 11	0 – Off	4.7.1
☐	1123	Gear Factor Numerator	-	-32767 ... 32767	1	4.7.2
☐	1124	Gear Factor Denominator	-	1 ... 65535	1	4.7.2
☐	1125	Phasing: Offset	u	$-(2^{31}-1) ... 2^{31}-1$	65536	4.7.4
☐	1126	Phasing: Speed	u/s	1 ... $2^{31}-1$	327680	4.7.4
☐	1127	Phasing: Acceleration	u/s ²	1 ... $2^{31}-1$	327680	4.7.4
	1128	Start Phasing	-	Selection: Logic signal	7 – Off	4.7.4
Homing						
	1130	Homing Mode	-	Selection: 0 ... 35	0 – no homing done	4.2.3
	1131	Home-Offset	u	$-(2^{31}-1) ... 2^{31}-1$	0	4.2.4
	1132	Fast Speed	u/s	1 ... $2^{31}-1$	327680	4.2.5
	1133	Creep Speed	u/s	1 ... $2^{31}-1$	163840	4.2.5
	1134	Acceleration	u/s ²	1 ... $2^{31}-1$	327680	4.2.5
	1135	Ramp Rise Time	ms	0 ... 2000	0	4.2.5
Digital inputs						
	1137	Neg. HW Limit Switch	-	Selection: Digital input	7 – Off	4.8.2
	1138	Pos. HW Limit Switch	-	Selection: Digital input	7 – Off	4.8.2
	1139	Home Switch	-	Selection: Digital input	75 – S6IND	4.2; 4.1.1
Act. Position Channel						
	1141	Actual Position Source	-	Selection 0 ... 3	0 – As P. 766 Actual Speed Source	3.5.1
Master Settings (el. gear)						
☐	1142	Resync. on Change of Gear-Factor	-	Selection: 0 ... 1	1 – On	4.7.3
Hardware Limit Switch						
	1143	Fault Reaction	-	Selection: 0 ... 3, 10	1 – Error-Switch-Off	4.8.2.2
Software limit switches						
☐	1144	Fault Reaction	-	Selection: 0 ... 3, 10	0 – Off	4.8.3
☐	1145	Pos. SW Limit Switch	u	$-(2^{31}-1) ... 2^{31}-1$	65536	4.8.3
☐	1146	Neg. SW Limit Switch	u	$-(2^{31}-1) ... 2^{31}-1$	-65536	4.8.3
Hardware Limit Switch						
☐	1149	Hysteresis	u	0 ... $2^{31}-1$	182	4.8.2.1
Target Window						
☐	1165	Target Window	u	0 ... $2^{20}-1$	182	4.8.4
☐	1166	Target Window Time	ms	1 ... 65535	1	4.8.4

Master Settings (el. gear)					
No.	Description	Unit	Setting range	Fact. sett.	Chapter
1168	"In-Gear"-Threshold	u	1 ... $2^{31}-1$	0	4.4.1.5
1169	"In-Gear"-Time	ms	1 ... 65535	10	4.4.1.5
Fixed Speed-Values					
1170	Fixed Speed 1	u/s	$-(2^{31}-1) \dots 2^{31}-1$	163480	4.5.1
1171	Fixed Speed 2	u/s	$-(2^{31}-1) \dots 2^{31}-1$	327680	4.5.1
1172	Fixed Speed 3	u/s	$-(2^{31}-1) \dots 2^{31}-1$	655360	4.5.1
1173	Fixed Speed 4	u/s	$-(2^{31}-1) \dots 2^{31}-1$	1310720	4.5.1
1174	Jog-Speed Keypad	u/s	$-(2^{31}-1) \dots 2^{31}-1$	163840	4.5.1
Ramps					
1175	Acceleration	u/s ²	1 ... $2^{31}-1$	327680	4.5.2
1176	Ramp Rise Time	ms	0 ... 2000	0	4.5.2
1177	Deceleration	u/s ²	1 ... $2^{31}-1$	327680	4.5.2
1178	Ramp Fall Time	ms	0 ... 2000	0	4.5.2
1179	Emergency Ramp	u/s ²	1 ... $2^{31}-1$	655360	4.5.2
System bus Synchronization					
1180	Operation mode	-	Selection: 0 ... 10	0 – Off	4.7.1
Motion Blocks					
1200	Motion Block Sel. (Writing)	-	0 ... 65	1	4.3.1
1201	Motion Block Sel. (Reading)	-	0 ... 65	1	4.3.1
1202	Target Position / Distance	u	$-2^{31} \dots 2^{31}-1$	65536	4.4.2.1
1203	Speed	u/s	$-(2^{31}-1) \dots 2^{31}-1$	163840	4.4.2.2
1204	Acceleration	u/s ²	1 ... $2^{31}-1$	327680	4.4.2.3
1205	Ramp Rise Time	ms	0 ... 2000	0	4.4.2.3
1206	Deceleration	u/s ²	1 ... $2^{31}-1$	327680	4.4.2.3
1207	Ramp Fall Time	ms	0 ... 2000	0	4.4.2.3
1208	Motion Mode	-	Selection: 0 ... 14	0 - absolute	4.4.1
1209	Touch-Probe-Window	u	0 ... $2^{31}-1$	65536	4.4.1.3
1210	Touch-Probe-Error: Next Motion Block	-	-3 ... 32	-2 – shut-down, error	4.4.1.3
1211	No. of Repetitions	-	0 ... 255	0	4.4.2.4
1212	Delay	ms	0 ... 65535	0	4.4.2.4
1213	Delay: Next Motion Block	-	-3 ... 32	0	4.4.2.4
1214	Event 1	-	Selection: Logic signal	7 – Off	4.4.2.4
1215	Event 1: Next Motion Block	-	-3 ... 32	0	4.4.2.4
1216	Event 2	-	Selection: Logic signal	7 – Off	4.4.2.4
1217	Event 2: Next Motion Block	-	-3 ... 32	0	4.4.2.4
1218	Digital Signal 1	-	Selection: 0 ... 212	0 – unv.	4.4.6
1219	Digital Signal 2	-	Selection: 0 ... 212	0 – unv.	4.4.6
Homing					
1220	Operation mode	-	Selection: 1 ... 2	2 – automatic	4.2.1
Control					
1221	Operation mode	-	Selection: 0 ... 302	102 – Sequence Mode w/o Restart	4.1; 4.1.2
Digital inputs					
1222	Start Positioning	-	Selection: Logic signal	71 – S2IND	4.4.5.1
1223	Stop Positioning	-	Selection: Logic signal	72 – S3IND	4.4.5.1

Digital inputs					
No.	Description	Unit	Setting range	Fact. sett.	Chapter
1224	Motion Block Change-Over 1	-	Selection: Logic signal	320 – EM-S1IND	4.4.3.1
1225	Motion Block Change-Over 2	-	Selection: Logic signal	321 – EM-S2IND	4.4.3.1
1226	Motion Block Change-Over 3	-	Selection: Logic signal	322 – EM-S3IND	4.4.3.1
1227	Motion Block Change-Over 4	-	Selection: Logic signal	7 – Off	4.4.3.1
Control					
1228	Starting-Record Number	-	1 ... 32	1	4.4.3.2
Digital inputs					
1230	Resume Motion Block	-	Selection: Logic signal	7 – Off	4.4.5.2
1231	Jog-Mode Active	-	Selection: Logic signal	76 – MFI1D	4.5
1232	Jog Clockwise	-	Selection: Logic signal	71 – S2IND	4.5
1233	Jog Anticlockwise	-	Selection: Logic signal	72 – S3IND	4.5
1235	Start Homing (manual)	-	Selection: Logic signal	7 – Off	4.2.1
Control					
1236	Speed Override	-	Selection: 0 ... 1	0 – Off	4.9
Digital inputs					
1239	Teach-In-Signal	-	Selection: Logic signal	76 – MFI1D	4.6
Rotary Table Function					
1240	Operation mode	-	Selection: 0 ... 4	0 – Off	4.11
1241	Units Per Revolution	u	1 ... $2^{31}-1$	65536	4.11
Position Comparator					
1242	Operation mode	-	Selection: Position source	9 – Off	4.10
1243	On-Position	u	$-2^{31} ... 2^{31}-1$	0	4.10
1244	Off-Position	u	$-2^{31} ... 2^{31}-1$	65536	4.10
1245	Hysteresis	u	0 ... $2^{31}-1$	182	4.10
Motion Blocks					
1247	Digital Signal 3	-	Selection: 0 ... 212	0 – unv.	4.4.6
1248	Digital Signal 4	-	Selection: 0 ... 212	0 – unv.	4.4.6
Digital inputs					
1254	Motion Block Change-Over 5	-	Selection: Logic signal	7 – Off	4.4.3.1
Motion Blocks					
1260	Interrupt-Event 1	-	Selection: Logic signal	7 – Off	4.4.2.4
1261	Int.-Event 1: Eval.-Mode	-	1 ... 6	1 – Level Controlled	4.4.2.4
1262	Int.-Event 1: Next Motion Block	-	-3 ... 32	0 – Disabled	4.4.2.4
1263	Interrupt-Event 2	-	Selection: Logic signal	7 – Off	4.4.2.4
1264	Int.-Event 2: Eval.-Mode	-	1 ... 6	1 – Level Controlled	4.4.2.4
1265	Int.-Event 2: Next Motion Block	-	-3 ... 32	0 – Disabled	4.4.2.4
Latching function					
1280	Operation Mode	-	0 ... 2	0 – Off	4.13

7.3 Parameter list, sorted by function

The parameter list is sorted by positioning functions. For the setting and display ranges, refer to numerically sorted parameter lists in chapters "Parameter Menu (PARA)" and "Actual Value Menu (VAL)".

Chapter	No.	Name of parameter	Chapter	No.	Name of parameter
Reference system			Motion Blocks		
3.5.2	1115	Feed Constant	4.3.1	1200	Motion Block Sel. (Writing)
3.5.2	1116	Gear Box: Driving shaft revolutions	4.3.1	1201	Motion Block Sel. (Reading)
3.5.2	1117	Gear Box: Motor shaft revolutions	4.4.2.1	1202	Target position / Distance
<hr/>			4.4.2.2	1203	Speed
Homing			4.4.2.2	1204	Acceleration
4.2.1	1220	Operation Mode	4.4.2.2	1205	Ramp Rise Time
4.2.1	1235	Start Homing (manual)	4.4.2.2	1206	Deceleration
4.2.3	1130	Homing Mode	4.4.2.2	1207	Ramp Fall Time
	1131	Home-Offset	4.4.1	1208	Motion Mode
4.2.5	1132	Fast Speed	4.4.1.3	1209	Touch-Probe-Window
4.2.5	1133	Creep Speed	4.4.1.3	1210	Touch-Probe-Error: Next Motion Block
4.2.5	1134	Acceleration	Automatic sequence		
4.2.5	1135	Ramp Rise Time	4.4.2.4	1211	No. of Repetitions
4.2.2	1139	Home Switch	4.4.2.4	1212	Delay
<hr/>			4.4.2.4	1213	Delay: Next Motion Block
JOG Mode			4.4.2.4	1214	Event 1
4.5	1231	Jog-Mode Active	4.4.2.4	1215	Event 1: Next Motion Block
4.5	1232	Jog Clockwise	4.4.2.4	1216	Event 2
4.5	1233	Jog Anticlockwise	4.4.2.4	1217	Event 2: Next Motion Block
4.5.1	1170	Fixed Speed 1	4.4.2.4	1260	Interrupt-Event 1
4.5.1	1171	Fixed Speed 2	4.4.2.4	1261	Int.-Event 1: Eval.-Mode
4.5.1	1172	Fixed Speed 3	4.4.2.4	1262	Int.-Event 1: Next Motion Block
4.5.1	1173	Fixed Speed 4	4.4.2.4	1263	Interrupt-Event 2
4.5.1	1174	Jog-Speed Keypad	4.4.2.4	1264	Int.-Event 2: Eval.-Mode
<hr/>			4.4.2.4	1265	Int.-Event 2: Next Motion Block
Ramps			Status indication		
4.5.2	1175	Acceleration	4.4.6	1218	Digital Signal 1
4.5.2	1176	Ramp Rise Time	4.4.6	1219	Digital Signal 2
4.5.2	1177	Deceleration	4.4.6	1247	Digital Signal 3
4.5.2	1178	Ramp Fall Time	4.4.6	1248	Digital Signal 4
4.5.2	1179	Emergency Ramp	Actual values:		
<hr/>			6.1;	1246	Actual Motion Block
Positioning control			4.4.2.4	1249	Motion Block to Resume
4.1.2	1221	Operation mode	4.4.5.2	1255	Actual Motion Mode
4.4.5.1	1222	Start Positioning	<hr/>		
4.4.5.1	1223	Stop Positioning	Teach-In		
4.4.5.2	1230	Resume Motion Block	4.6	1239	Teach-In-Signal
4.4.3.1	1224	Motion Block Change-Over 1	<hr/>		
4.4.3.1	1225	Motion Block Change-Over 2	Position Comparator		
4.4.3.1	1226	Motion Block Change-Over 3	4.10	1242	Operation mode
4.4.3.1	1227	Motion Block Change-Over 4	4.10	1243	On-Position
4.4.3.1	1254	Motion Block Change-Over 5	4.10	1244	Off-Position
4.4.3.2	1228	Starting-Record Number	4.10	1245	Hysteresis
<hr/>			<hr/>		

Chapter	No.	Name of parameter
Master Settings (el. gear)		
4.7.1	1122	Master Position Source
4.7.2	1123	Gear Factor Numerator
4.7.2	1124	Gear Factor Denominator
4.7.3	1142	Resync. on Change of Gear-Factor
4.7.4	1125	Phasing: Offset
4.7.4	1126	Phasing: Speed
4.7.4	1127	Phasing: Acceleration
4.7.4	1128	Start Phasing
4.4.1.5	1168	"In-Gear"-Threshold
4.4.1.5	1169	"In-Gear"-Time
Actual value:		
6.1; 4.4.1.5	1129	Act. Master Speed
Monitoring functions:		
Hardware Limit Switch		
4.8.2.2	1143	Fault Reaction
4.8.2	1137	Neg. HW Limit Switch
4.8.2	1138	Pos. HW Limit Switch
4.8.2.1	1149	Hysteresis
Software limit switches		
4.8.3	1144	Fault Reaction
4.8.3	1145	Pos. SW Limit Switch
4.8.3	1146	Neg. SW Limit Switch
Contouring error monitoring		
4.8.5	1105	Warning Threshold
4.8.5	1106	Error Threshold
4.8.5	1119	Contouring Error Time
4.8.5	1120	Fault Reaction
Actual values:		
6.1; 4.8.5	1109	Act. Contouring Error
6.1; 4.8.5	1121	Peak Value Contouring Error
Target Window		
4.8.4	1165	Target Window
4.8.4	1166	Target Window Time
Warning application		
4.8.6	626	Create Appl. Warning Mask
Actual values:		
6.1; 4.8.6	273	Application Warnings
6.7; 4.8.6	367	Application Warning Status
6.1; 4.8.6	627	Actual Appl. Warning Mask

Chapter	No.	Name of parameter
Speed Override		
4.9	1236	Speed Override
Rotary table		
4.11	1240	Operation Mode
4.11	1241	Units Per Revolution
Position controller		
4.12	1104	Time Constant
4.12	1118	Limitation
Position encoder		
3.5.1	1141	Actual Position Source
Act. values		
6.1	1107	Act. Speed
6.1	1108	Act. Position
Latching function		
4.13	1280	Operation Mode
Actual value:		
4.13	1281	Latched Position

Index

A

Acceleration	
Electronic Gear	48
Homing	38
JOG	81
Motion block.....	55
Phasing	87
Actual position source.....	18, 19
Actual speed source	18, 19
Actual values	151

C

Commissioning.....	10
Procedure.....	16
Components required	8
Contouring error supervision	100
Control inputs and outputs	
ACU	12
Control inputs assignment.....	29
Control via software	25
Creep speed	38

D

Deceleration	
Homing	38
JOG	81
Motion block.....	55
Diagnosis.....	162
Digital output signals	155
Digital signal for motion status	73

E

Electronic gear	85
Gear factor	87
Motion mode	48
Encoder.....	18, 114
Error messages	158
Contouring error supervision	100
Hardware limit switches.....	92, 94
Homing	35
JOG mode	77
Software limit switches	96, 97
Teach-In	83

Expansion modules.....	8
------------------------	---

F

Factory settings.....	164
Fast speed	38
Fault reaction	
Hardware limit switches.....	94
Software limit switches	96
Fixed speed in JOG mode.....	79

G

Gear Box	
Motor shaft revolutions.....	21
Gear Box	
Driving shaft revolutions	21
Gear factor	
Calculation	23
Electronic gear.....	87

H

Hardware limit switches	90
Fault reaction	94
Hysteresis	93
Homing	34, 115
Acceleration.....	38
Automatic start	34
Creep speed	38
Fast speed.....	38
Home offset.....	38
Homing done	36
Homing modes	37
Input signals.....	35
Manual start	34
Output signals	35
Ramp rise time	39
Speed	38
Terminal assignment	35
Homing modes	
Actual position	150
only reference signal	150
Terminology	119
with reference signal	121
without reference signal	137
Homing modes overview	
Brief description.....	115
Detailed description	120
Graphic overview	118
List of modes.....	115
Table	117
Hysteresis	
Hardware limit switches.....	93
Position comparator	105

I		P	
Interrupt	55, 59	Parameter list	
J		numerical order	164
JOG mode	76	sorted by function	168
Acceleration.....	81	Phasing	87
Deceleration	81	Position comparator.....	105
Fixed speed.....	79	Position controller.....	110
Terminal assignment	77	Position deviation	111
via keypad.....	80	Position encoder.....	18
L		Positioning	
Latching function.....	112	Actual values	151
Limit switches		Automatic.....	55
Hardware limit switches.....	90	Components	8
Software limit switches	95	Control.....	31, 63
Logic signals	156	Digital output signals.....	155
M		Error messages	158
Master position	85	Getting started.....	18
Monitoring functions		Logic signals.....	156
Contouring error supervision	100	Motion block change-over	63
Fault reaction	94, 95	Operation modes	28
Hardware limit switches.....	90	Resuming	72
Software limit switches	95	Scope of functions.....	8
Target window.....	99	Sequence mode	55
Travel limits.....	90	Single motion	62
Warning mask	102	Start and Stop	67, 68
Motion blocks.....	39	Starting-record number	65
Automatic sequence	55	Status word	152
Input data	54	Terminal assignment	66
Mode	41	Warning status	162
Motion block change-over	63	Positioning status word	152
Selection	63, 65	Positioning mode	39
VTable	40	R	
Motion control.....	63	Ramp rise time of homing	39
Motion mode.....	41	Read index	26
Absolute.....	44	Reference system.....	21
Gearing	48	Resuming motion blocks	72
Relative.....	44	Resynchronization	87
Touch probe.....	45	Rotary table.....	22, 107
Velocity	47	Operation mode.....	107
Motion profile		Optimized (shortest way).....	108
Example.....	24	Reference system.....	22
Motor encoder	18	S	
Multifunction input	30	Safety instructions.....	5
N		Scope of functions.....	8
Next motion block	55	Sequence mode	55
O		Single motion.....	62
Offset		Software for control.....	25
Home offset.....	38	Software limit switches	95
Phasing	87	Fault reaction	96
		Move away from SW limit switches	98
		Speed	
		Homing	38

JOG mode	79	Teach-In	81
JOG speed keypad	80	Terminal diagram	
Motion blocks	54	ACTIVE Cube (ACU)	9
Phasing	87	Touch probe	45
Speed override.....	104	Transport and Storage	6
Starting-record number.....	65		
Status of motion.....	73	U	
Status word 411.....	154	U (revolution)	21
Store		u (units)	21
Actual position value	112		
T		V	
Target position.....	54	VTable.....	40
Target window	99		
Teach-In	81	W	
Terminal assignment		Warning mask.....	102
Homing	35	Warning status.....	162
JOG mode	77	Write index.....	26
Positioning.....	66		



Bonfiglioli Worldwide & BEST Partners

AUSTRALIA

BONFIGLIOLI TRANSMISSION (Aust) Pty Ltd.
101, Plumpton Road, Glendenning NSW 2761, Australia
Locked Bag 1000 Plumpton NSW 2761
Tel. (+61) 2 8811 8000 - Fax (+61) 2 9675 6605
www.bonfiglioli.com.au - sales@bonfiglioli.com.au

AUSTRIA **BEST**

MOLL MOTOR GmbH
Industriestrasse 8 - 2000 Stockerau
Tel. (+43) 2266 63421+DW - Fax (+43) 6342 180
www.mollmotor.at - office@mollmotor.at

BELGIUM **BEST**

ESCO TRANSMISSION N.V./S.A.
Culliganlaan 3 - 1831 Machelem Diegem
Tel. (+32) 2 7176460 - Fax (+32) 2 7176461
www.esco-transmissions.be - info@esco-transmissions.be

BRASIL **BEST**

ATI BRASIL
Rua Omlio Monteiro Soares, 260 - Vila Fanny - 81030-000
Tel. (+41) 334 2091 - Fax (+41) 332 8669
www.atibrasil.com.br - vendas@atibrasil.com.br

CANADA

BONFIGLIOLI CANADA INC.
2-7941 Jane Street - Concord, ONTARIO L4K 4L6
Tel. (+1) 905 7384466 - Fax (+1) 905 7389833
www.bonfigliolicanada.com - sales@bonfigliolicanada.com

CHINA

BONFIGLIOLI DRIVES (SHANGHAI) CO. LTD.
No. 8 Building, 98 Tian Ying Road
Qingpu District, Shanghai, PRC 201712
Tel. +86 21 69225500 - Fax +86 21 69225511
www.bonfiglioli.cn - bds@bonfiglioli.com.cn

FRANCE

BONFIGLIOLI TRANSMISSIONS S.A.
14 Rue Eugène Pottier BP 19
Zone Industrielle de Moimont II - 95670 Marly La Ville
Tel. (+33) 1 34474510 - Fax (+33) 1 34688800
www.bonfiglioli.fr - bf@bonfiglioli.fr

GERMANY

BONFIGLIOLI DEUTSCHLAND GmbH
Sperberweg 12 - 41468 Neuss
Tel. (+49) 02131 2988-0 - Fax (+49) 02131 2988-100
www.bonfiglioli.de - info@bonfiglioli.de

GREAT BRITAIN

BONFIGLIOLI UK Ltd
Industrial Equipment - Unit 3 Colemeadow Road
North Moons Moat - Redditch, Worcestershire B98 9PB
Tel. (+44) 1527 65022 - Fax (+44) 1527 61995
www.bonfiglioli-uk.com - uksales@bonfiglioli-uk.com

Mobile Equipment

5 Grosvenor Grange - Woolston - Warrington, Cheshire WA1 4SF
Tel. (+44) 1925 852667 - Fax (+44) 1925 852668
www.bonfiglioli-uk.com - salesmobile@bonfiglioli-uk.com

GREECE

BONFIGLIOLI HELLAS
O.T. 48A T.O. 230 - C.P. 570 22 Industrial Area - Thessaloniki
Tel. (+30) 2310 796456 - Fax (+30) 2310 795903
www.bonfiglioli.gr - info@bonfiglioli.gr

HOLLAND **BEST**

ELSTO AANDRIJFTECHNIEK
Loostenweg, 7 - 2215 TL Voorhout
Tel. (+31) 252 219 123 - Fax (+31) 252 231 660
www.elsto.nl - imfo@elsto.nl

HUNGARY **BEST**

AGISYS AGITATORS & TRANSMISSIONS Ltd
2045 Törökbalint, Tó u.2. Hungary
Tel. +36 23 50 11 50 - Fax +36 23 50 11 59
www.agisys.hu - info@agisys.hu

INDIA

BONFIGLIOLI TRANSMISSIONS PVT Ltd.
PLOT AC7-AC11 Sidco Industrial Estate
Thirumudivakkam - Chennai 600 044
Tel. +91(0)44 24781035 / 24781036 / 24781037
Fax +91(0)44 24780091 / 24781904
www.bonfiglioli.co.in - bonfig@vsnl.com

ITALY

BONFIGLIOLI ITALIA S.p.A.
Via Sandro Pertini lotto 7b - 20080 Carpiano (Milano)
Tel. (+39) 02 985081 - Fax (+39) 02 985085817
www.bonfiglioli.it - customerservice.italia@bonfiglioli.it

NEW ZEALAND **BEST**

SAECO BEARINGS TRANSMISSION
36 Hastie Avenue, Mangere
Po Box 22256, Otahuhu - Auckland
Tel. +64 9 634 7540 - Fax +64 9 634 7552
mark@saeco.co.nz

POLAND **BEST**

POLPACK Sp. z o.o. - Ul. Chrobrego 135/137 - 87100 Torun
Tel. (+48) 56 6559235 - 6559236 - Fax (+48) 56 6559238
www.polpack.com.pl - polpack@polpack.com.pl

PORTUGAL **BEST**

BT BONFITEC Equipamentos Industriais, Lda.
Largo do Colegio de Ermesinde, 70 - Formiga 4445-382 Ermesinde
Tel. (+351) 229759634/5/6 - Fax (+351) 229752211
www.bonfitec.pt - bonfitec@bonfitec.pt

RUSSIA **BEST**

FAM
57, Maly prospekt, V.O. - 199048, St. Petersburg
Tel. +7 812 3319333 - Fax +7 812 3271454
www.fam-drive.ru - info@fam-drive.ru

SPAIN

TECNOTRANS BONFIGLIOLI S.A.
Pol. Ind. Zona Franca sector C, calle F, nº6 08040 Barcelona
Tel. (+34) 93 4478400 - Fax (+34) 93 3360402
www.tecnotrans.com - tecnotrans@tecnotrans.com

SOUTH AFRICA

BONFIGLIOLI POWER TRANSMISSION Pty Ltd.
55 Galaxy Avenue, Linbro Business Park - Sandton
Tel. (+27) 11 608 2030 OR - Fax (+27) 11 608 2631
www.bonfiglioli.co.za - bonfigsales@bonfiglioli.co.za

SWEDEN

BONFIGLIOLI SKANDINAVIEN AB
Koppargatan 8 - 234 35 Lomma, Sweden
Tel. (+46) 40418230 - Fax (+46) 40414508
www.bonfiglioli.se - info@bonfiglioli.se

THAILAND **BEST**

K.P.T MACHINERY (1993) CO.LTD.
259/83 Soi Phiboonves, Sukhumvit 71 Rd. Phrakhanong-nur,
Wattana, Bangkok 10110
Tel. 0066.2.3913030/7111998
Fax 0066.2.7112852/3811308/3814905
www.kpt-group.com - sales@kpt-group.com

USA

BONFIGLIOLI USA INC
3541 Hargrave Drive Hebron, Kentucky 41048
Tel.: (+1) 859 334 3333 - Fax: (+1) 859 334 8888
www.bonfiglioliusa.com
industrialsales@bonfiglioliusa.com
mobilesales@bonfiglioliusa.com

VENEZUELA **BEST**

MAICA SOLUCIONES TECNICAS C.A.
Calle 3B - Edif. Comindu - Planta Baja - Local B
La Urbina - Caracas 1070
Tel. (+58) 212 2413570 / 2425268 / 2418263
Fax (+58) 212 2424552 - Tlx 24780 Maica V
maica1@cantv.net

HEADQUARTERS

BONFIGLIOLI RIDUTTORI S.p.A.
Via Giovanni XXIII, 7/A
40012 Lippo di Calderara di Reno
Bologna (ITALY)
Tel. (+39) 051 6473111
Fax (+39) 051 6473126
www.bonfiglioli.com
bonfiglioli@bonfiglioli.com

SPARE PARTS BONFIGLIOLI

B.R.T.
Via Castagnini, 2-4
Z.I. Bargellino - 40012
Calderara di Reno - Bologna (ITALY)
Tel. (+39) 051 727844
Fax (+39) 051 727066
www.brtbonfigliolicambi.it
brt@bonfiglioli.com

ACTIVE Cube



www.bonfiglioli.com

 **BONFIGLIOLI**